

SUMNER*

A Southwire Company

Welding Make-up Tools



At Sumner Manufacturing, our welding customers are very important people.

One of our primary goals as a manufacturer is to provide our customers with high quality, competitively priced tools. But welders are not only our customers — we learn from the welder in the field what products are needed to make their jobs easier. These ideas help us to design and build new and better products. In essence, our customers are part of our Research & Development department, and without your input, we would be unable to continually offer great new products.

Another important part of our philosophy at Sumner is our commitment to safety. All Sumner employees are dedicated to the safety of the individuals who use our products. We understand that price is always a concern to our users, but we will never sacrifice quality or safety just to save costs. We know the demands expected of all Sumner products, and each is built for years of use. It could be said that Sumner tools are built the way the welder would make them. As a result, our tools are not only considered the best in the market, but also the most reliable to get the job done efficiently and safely.

Visit us at sumner.com to see what's exciting and new.



Sumner Manufacturing Co., LLC
www.sumner.com

Table of Contents

Pipe Stands

Adust-A Roll.....	8
Beam Jax.....	16
Big V.....	11
Big V Specs.....	13
FAB SAFJack	7
Fat Jack	7
Hi Boy	7
Max Jax.....	12
Max Jax Specs.....	13
Max Jax 2.....	4-15
Mini-Roll.....	8
Pipe Jacks.....	4-6
Pro Roll & Roller Stand Head Styles.....	9
Qwik Change & Specs.....	10

Fit-Up Tools

Adjust-A-Fit.....	21
Adjust-A-Flange.....	21
Center Punch.....	32
Clamp Champ.....	22-23
DX Clamp.....	20
Expansion Plugs.....	36-37
Fab Mate.....	21
Fit Kits.....	29
Flange Leveler.....	27
Flange Pins.....	27
Flange Spreaders.....	28
Internal Fit-Up Clamp.....	17
Levels.....	31
Magnetic Holder.....	33
Mul-T-Square	33
PFAST.....	24-25

Fit-up Tools continued...

Purge Star.....	34
Qwik Pins.....	26
Ring Purge.....	35
Rotary Ground Clamp.....	29
Standard Square	30
Ultra Clamp / Ultra Qwik Clamp.....	18-19
Ultra Fit / Ultra Qwik Fit.....	18-19
Universal Center Punch.....	32
Welder's Stool.....	26
Welding Gage.....	30

Carts / Storages

Bundle Mac.....	40
Cricket.....	43
Cylinder Carts.....	44-47
Grasshopper.....	43
Handi-Bench.....	42
Hanger Mac.....	40
Mac Rack I & II.....	41
Pipe Mac.....	41
Stor Mac.....	38
Tainer Mac.....	39
Weldbox.....	42

Sumner* Pipe Stands

Standard Features on all Sumner Jacks:

- ✓ 1-1/2" (38 mm) Acme fine adjustment thread — the largest in the industry
- ✓ Large, convenient adjustment handle
- ✓ CE rated
- ✓ Quick-action lock washer
- ✓ Fall Guard™ Support
- ✓ Set screw can lock jack head to stand — no loose pieces
- ✓ Jack independently load tested for quality assurance
- ✓ Backed by over forty years of jack stand manufacturing experience



PIPE STANDS

Heavy Duty Jacks

Special Features:

- ✓ 2,500 lb (1,135 kg) capacity
- ✓ Strut tension plate for superior lateral support
- ✓ 1" (2.5 cm) square tube base construction
- ✓ Built for heavy use & abuse



Hi Heavy Duty Jack
28"-49" (71-125 cm)



Lo Heavy Duty Jack
21"-36" (51-89 cm)

Heavy Duty Jack Plus

- ✓ 3,500 lb (1,580 kg) capacity
- ✓ Rib-supported vee head prevents "pancaking"
- ✓ Strut tension plate for superior lateral support
- ✓ 1" (2.5 cm) square tube base construction



Heavy Duty Jack Replacement Legs
for easy repair
(Part # 780675-KD)



"Pro Jack"*

Special Features:

- ✓ Formed steel legs
- ✓ 2,500 lb (1,135 kg) capacity
- ✓ Priced for all budgets
- ✓ Strut tension plate for superior lateral support

Hi Pro Jack
28"-49" (71-125 cm)



Fold-A-Jack*

Special Features:

- ✓ 2,500 lb (1,135 kg) capacity
- ✓ Folds up for storage ease
- ✓ 1" (2.5 cm) square tube base construction
- ✓ Convenient carrying handle





Lo Fold-A-Jack
21"-36" (51-89 cm)



Hi Fold-A-Jack
28"-49" (71-125 cm)



Sumner Offers a Choice of 5 Head Styles for every Jack Application:

					
Model	Standard Vee Head	Ball Transfer Head	Steel Wheel Head	Rubber Wheel Head	Bar Stock Head
Part Number (carbon steel)	780518	780518 & 780551	780514	780499	780519 (Hi) 780944 (Lo)
Part Number (stainless steel)	780498	780518 & 780274	780517	N/A	N/A
Pro Jack, Heavy Duty Jack & Fold-A-Jack Capacity	2,500 lb 1,135 kg	1,000 lb 450 kg	2,500 lb 1,135 kg	1,000 lb 450 kg	2,000 lb 900 kg
Pipe Size (min - max)	1/8" - 24" 3-600 mm	3/8" - 12" 10-300 mm	1-1/4" - 24" 30-600 mm	1-1/2" - 24" 40-600 mm	1/8" - 10" (Flat) 3-250 mm

PIPE STANDS

Stainless Steel Vee Head Attachment Part # 780502

Fits over vee and secures with two bolts – no tools required!



Standard Vee Head Ball Transfer Set

Part # 780551 (carbon steel)
Part # 780274 (stainless steel)

Attachments slide over standard vee head. Accommodates 3/8" - 12" (10 - 300 mm) pipe sizes. 1,000 lb (450 kg) capacity.



Hi Jack Height Range

Maximum 49" 125 cm
Minimum 28" 71 cm

Hi Jacks are used for perfect work height on shapes or pipe

Lo Jack Height Range

Maximum 36" 89 cm
Minimum 21" 51 cm

Lo Jacks are used for larger shapes or pipe

Hold-Down Device

Similar in operation to a chain vise for pipe, the **Hold-Down Device** uses high tensile strength chain to grip material in any Sumner vee head jack. Ideal for fitting up flanges, fittings or valves, and a must when working with short lengths.

Holds Pipe or Shape up to 12" Diameter!



Part #	Description	Weight	
		lbs	kg
781050	ST-448 Hold-Down Device	6.0	2.7
781056	15' Safety Brakes	4.0	1.8

Jack Stand Specifications

Part #	Description	Weight	
		lbs	kg
HI HEAVY DUTY JACKS			
780375	ST-801 w/Vee Head	24.0	10.9
780376	ST-802 w/Roller Head	27.0	12.2
780377	ST-803 w/Bar Stock Head	24.0	10.9
780378	ST-804 w/Stainless Steel Rollers	28.0	12.7
780379	ST-805 w/Stainless Steel Vee Head	24.0	10.9
780380	ST-806 w/Ball Transfer Head	27.0	12.2
780381	ST-807 w/Rubber Wheels	26.0	11.8
HEAVY DUTY JACK PLUS (HI JACK)			
780326	w/Ribbed Vee Head	24.0	10.9
LO HEAVY DUTY JACK PLUS			
780385	ST-901 w/Vee Head	19.0	8.6
780386	ST-902 w/Roller Head	22.0	10.0
780387	ST-903 w/Bar Stock Head	18.0	8.2
780388	ST-904 w/Stainless Steel Rollers	22.0	10.0
780389	ST-905 w/Stainless Steel Vee Head	19.0	8.6
780390	ST-906 w/Ball Transfer Head	22.0	10.0
780391	ST-907 w/Rubber Wheels	21.0	9.5

NOTE: Jacks ordered with stainless steel vee heads are shipped with a standard vee head and stainless steel vee head attachment (PN 780502). See page 5 for details on stainless steel vee-head attachment.

Part #	Description	Weight	
		lbs	kg
HI FOLD-A-JACKS®			
781300	ST-881 w/Vee Head	25.0	11.3
781301	ST-882 w/Roller Head	28.0	12.7
781302	ST-883 w/Bar Stock Head	25.0	11.4
781303	ST-884 w/Stainless Steel Rollers	29.0	13.1
781304	ST-885 w/Stainless Steel Vee Head	24.0	10.9
781305	ST-886 w/Ball Transfer Head	29.0	13.1
781306	ST-887 w/Rubber Wheels	26.0	11.8
LO FOLD-A-JACKS®			
781310	ST-981 w/Vee Head	21.0	9.5
781311	ST-982 w/Roller Head	24.0	10.9
781313	ST-984 w/Stainless Steel Rollers	24.0	10.9
781314	ST-985 w/Stainless Steel Vee Head	22.0	10.0
781315	ST-986 w/Ball Transfer Head	25.0	11.3
781316	ST-987 w/Rubber Wheels	22.0	10.0
HI PRO JACKS®			
780471	ST-871 w/Vee Head	23.0	10.4
780472	ST-872 w/Roller Head	26.0	11.8
780473	ST-873 w/Bar Stock Head	23.0	10.4
780474	ST-874 w/Stainless Steel Rollers	26.0	11.8
780475	ST-875 w/Stainless Steel Vee Head	24.0	10.9
780476	ST-876 w/Ball Transfer Head	28.0	12.7
780477	ST-877 w/Rubber Wheels	25.0	11.4

HOLD-E* Patented.

A Quick, Easy, Safe Clamp For Holding Pipe In Vee Head Jack Stands

NOW IN STAINLESS STEEL!



Perfect for securing pipe layout work

Threads permit positive gripping of pipe to vee head

Rugged steel frame for years of use



Grips 3/4" - 6" pipe (20 - 152mm) or 1" - 6-1/2" tubing (25 - 165mm)



Quick release button allows clamp arms to open and close in seconds.



Arms extend open in raised position



Part #	Description	Weight	
		lbs	kg
785000	Hold-E* Pipe Clamp (3/4" - 6" pipe)	8.7	3.9
784999	SS Hold-E* Pipe Clamp (3/4" - 6" pipe)	8.7	3.9

CAUTION: Hold-E device is a clamping device and should not be used for threading or lifting.

FAT JACK™

- ✓ 6,000 lb (2,725 kg) vee head capacity
- ✓ 1-1/4" square tube base construction
- ✓ Midi & Maxi with folding base
- ✓ Convenient carrying handle
- ✓ 7" vee head



Part #	Description	Min Height	Max Height	Base	lbs	kg
785252	Mini Fat Jack w/Roller Head	16" / 40.6 cm	28.5" / 72.4 cm	19" x 19" x 19" 48.3 cm x 48.3 cm x 48.3 cm	28.0	11.4
785251	Midi Fat Jack w/Roller Head	26.5" / 67.3 cm	44.5" / 113.0 cm	21" x 21" x 21" 53.3 cm x 53.3 cm x 53.3 cm	37.0	16.8
785250	Maxi Fat Jack w/Roller Head	36" / 91.4 cm	61" / 154.9 cm	34" x 34" x 34" 86.3 cm x 86.3 cm x 86.3 cm	47.0	21.4



PIPE STANDS

Hi Boy™ JACK STAND

The Hi Boy stand is a tall jack specifically designed for tight pipe installation, such as in mechanical rooms or tunnels. The Hi Boy stand is a safe, portable folding stand that is easy to transport and holds a hefty 1,000 pounds (450 kg) at 72" (180 cm). In its lowest position of 39" (98 cm), the Hi Boy is ideal for normal fabrication of weld pipe. Legs fold up for convenient storage in job boxes or truck beds.



39" to 72"
(98-180 cm)
Height Range!



38" (96 cm)
wide base



Part #	Description	Weight	
		lbs	kg
783250	Hi Boy Jack Stand	45.0	20.4

FAB SAF™ Jack

Great for Serious Fabrication!

Special Features:

- ✓ 3,500 lb (1,580 kg) vee head load capacity
- ✓ 2,500 lb (1,135 kg) roller head load capacity
- ✓ 30" (76 cm) wide base
- ✓ Height range 32" to 52" (81 to 132 cm)
- ✓ Large ribbed vee head to accommodate 36" (900 mm) pipe
- ✓ Quick-Action Lock Washer



Part #	Description	Weight	
		lbs	kg
780395	FAB SAF Jack	26.0	11.8
780400	FAB SAF Jack w/Roller	26.0	11.8

Adjust-A-Rolls™

- ✓ Roller adjustment from either side
- ✓ Fast adjustment for easy pipe positioning
- ✓ 1/2" to 36" (12–900 mm), or 2,500 lb (1,135 kg) pipe capacity
- ✓ Clean and simple design avoids welder interference
- ✓ Wheels trued for true pipe rotation
- ✓ Bronze bearing to eliminate arcing
- ✓ Brake to lock loads for layout or fit-up
- ✓ Handle large enough to work with gloved hand

PIPE STANDS

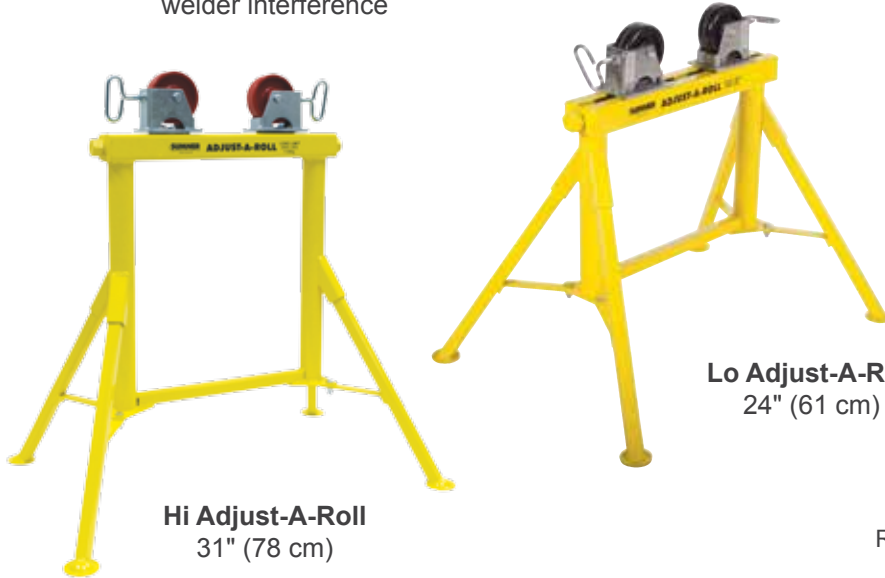

Hi Adjust-A-Roll
31" (78 cm)

Lo Adjust-A-Roll
24" (61 cm)



Table Adjust-A-Roll



Replacement legs
for easy repair
(Part # 780675-KD)

Mini-Roll

- ✓ ½ to 36" (1.2 to 91 cm) pipe capacity
- ✓ 3,500 lb (1580 kg) weight capacity
- ✓ Roller adjusts from either side
- ✓ Quick Change Roller Heads
- ✓ Brake to lock loads for layout
- ✓ No need for wedges

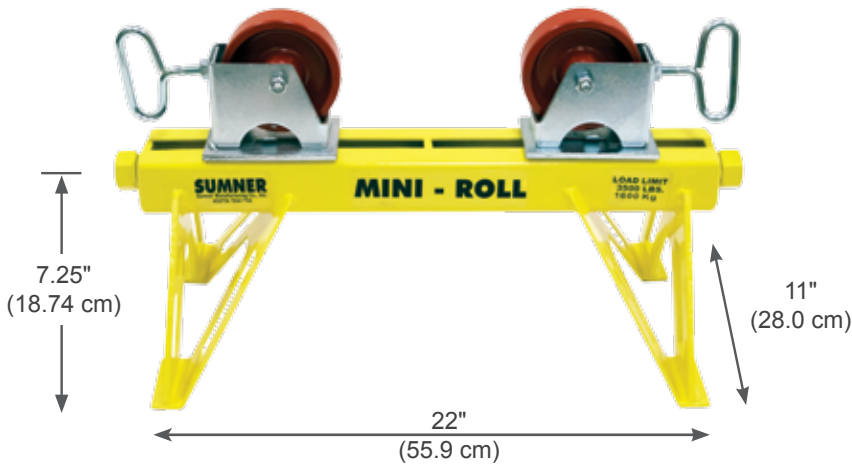

Pro Roll™

NEWLY IMPROVED!



- ✓ Improved lock washer design
- ✓ More features
- ✓ Adjustable height
- ✓ 1/2" to 36" (1.2–91 cm) or 2,500 lb (1,135 kg) capacity
- ✓ Leveling on either side of stand
- ✓ Uses Quick Change Housings



PIPE STANDS

ROLLER HEAD OPTIONS

 <p>Carbon Steel or Stainless Steel Roller Head (PN 783151) 2,500 lb (1,135 kg) capacity</p>	 <p>Rubber Wheel Roller Head (PN 783152) 1,200 lb (550 kg) capacity</p>	 <p>Ball Transfer Roller Head (PN 783154) 1,000 lb (450 kg) capacity carbon or stainless steel balls</p>	 <p>Bar Stock Head (PN 783155) 2,000 lb (900 kg) capacity Two position roller for containment or non-containment of material</p>
--------------------------------------------------------------------------------------------------------------------------------------------------------------------------------------------	-----------------------------------------------------------------------------------------------------------------------------------------------------------------------	-------------------------------------------------------------------------------------------------------------------------------------------------------------------------------------------------------------	--------------------------------------------------------------------------------------------------------------------------------------------------------------------------------------------------------------------------------------

Hi & Lo Adjust-A-Roll™ Specifications				
	Height	Width	Depth	Load Capacity
Hi Adjust-A-Roll	31.0" (78 cm)	31.0" (78 cm)	23" (58.4 cm)	2,500 lb (1,135 kg)
Lo Adjust-A-Roll	24.0" (78 cm)	31.0" (78 cm)	23" (58.4 cm)	2,500 lb (1,135 kg)

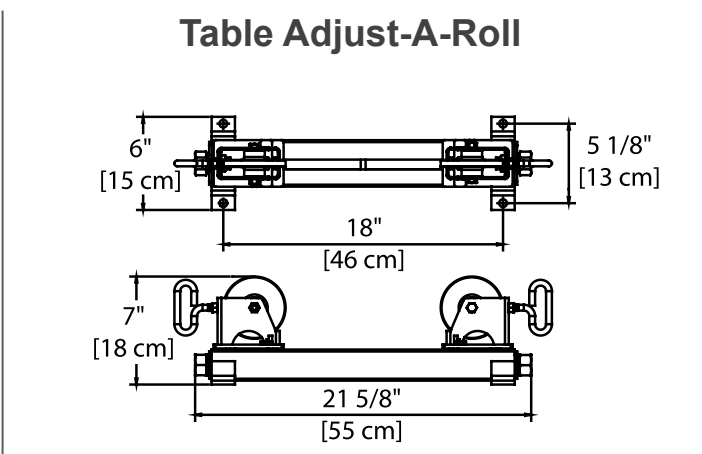

Quick Change Roller Housings

for SUMNER Pro Roll™ & Adjust-A-Roll™ Stands

Sumner's innovative Quick Change Roller Housings increase the utility of its roller stand product line. Roller housings can be changed in a snap, without tools, to adapt to changing job needs.

Roller wheels available in steel, stainless steel or rubber. Ball transfer heads, with carbon or stainless steel balls, and bar stock heads are also available.



Part #	Description	Weight	
		lbs	kg
783151	Quick Change Housing with Roller Wheels	8.0	3.6
783152	Quick Change Housing with Rubber Wheels	7.0	3.2
783153	Quick Change Housing with Roller Wheels	8.0	3.6
783154	Quick Change Housing with Ball Transfer Head	7.0	3.2
783155	Quick Change Housing with Bar Stock Head	16.0	7.2
783159	Quick Change Housing with Stainless Steel Ball Transfer Head	8.0	3.6

Hi Adjust-A-Roll

Part #	Description	Weight	
		lbs	kg
780365	ST-601 with roller wheels	35.0	15.8
780366	ST-602 with ball transfer heads	38.0	17.3
780367	ST-603 with rubber wheels	34.0	15.4
780368	ST-604 with stainless steel wheels	35.0	15.8
780369	ST-605 with bar stock head	39.0	17.6
780399	Hi Adjust-A-Roll [base only]	28.0	12.7

Lo Adjust-A-Roll

Part #	Description	Weight	
		lbs	kg
780370	ST-701 with roller wheels	34.0	15.4
780371	ST-702 with ball transfer heads	24.0	10.9
780372	ST-703 with rubber wheels	32.0	14.5
780373	ST-704 with stainless steel wheels	34.0	15.4
780359	ST-705 with bar stock head	37.0	16.8
780405	Lo Adjust-A-Roll [base only]	26.0	11.8

Table Adjust-A-Roll

Part #	Description	Weight	
		lbs	kg
780360	ST-501 with roller wheels	22.0	10.0
780361	ST-502 with ball transfer heads	22.0	10.0
780362	ST-503 with rubber wheels	20.0	9.0
780363	ST-504 with stainless steel wheels	22.0	10.0
780364	ST-505 with bar stock head	24.0	10.9
780500	Table Adjust-A-Roll [base only]	13.0	5.9

Pro Roll

Part #	Description	Weight	
		lbs	kg
780440	Pro Roll [base only]	38.0	17.2
780441	Pro Roll with roller wheels	47.0	21.3
780442	Pro Roll with ball transfer heads	49.0	22.2
780443	Pro Roll with rubber wheels	45.0	20.4
780444	Pro Roll with stainless steel wheels	47.0	21.3
780446	Pro Roll with bar stock head	49.0	22.2

Mini-Roll

Part #	Description	Weight	
		lbs	kg
785280	Mini Roll w/roller wheels	23.0	10.4
785281	Mini Roll w/ball transfer heads	22.0	10.0
785282	Mini Roll w/rubber wheels	22.0	10.0
785283	Mini Roll w/stainless steel wheels	23.0	10.4
785284	Mini Roll w/bar stock head	31.0	14.1
785288	Mini Roll w/S.S. ball transfer heads	23.0	10.4
785285	Mini Roll - base only	15.0	6.8

Hi Adjust-A-Roll, Lo Adjust-A-Roll, and Pro Roll have a width of 31" (80 cm) and a depth of 23" (58.5 cm).

Mini-Roller has a height of 7.25" (18.4 cm).

BIG*

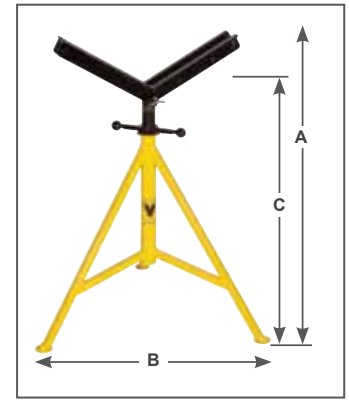

Basic Big V
(Part# 780260)

Specifications		
Load Capacity		2,500 lb (1,135 kg)
Basic Unit	A (height)	35.5" (902 mm)
	B (width)	29.5" (749 mm)
Vee Head Height	C (min)	29.5" (749 mm)
	(max)	41.0" (1,041 mm)

The Big V Jack is a low cost stand for 4 - 36 (100 - 915 mm) pipe.*

Large Vee Head Jack Accessories

<p>Roller Wheel Kit (PN 781381) Capacity 2500 lb/1135 kg</p>  <p>Roller Wheel Kit Wide roller wheels provide smoother pipe rotation with less effort.</p>	<p>Stainless Steel Wheel Kit (PN 781407) Capacity 2000 lb/900 kg</p>  <p>Stainless Steel Wheel Kit Provides four roller wheels which can be quickly mounted into the 12" (30 cm) vee head. Roller wheels come in either steel or stainless steel.</p>	<p>Rubber Wheel Kit (PN 781394)</p>  <p>Rubber Wheel Kit Consists of four rubber wheels and hardware so that it can be mounted into the 12" (30 cm) vee head. 1,000 lb (450 kg) capacity.</p>
<p>Stainless Steel Sleeves (PN 781382) Capacity 2500 lb/1135 kg</p>  <p>Stainless Steel Sleeves When working with stainless steel pipe, the sleeve option instantly converts the Max Jax stand to a specialty tool for stainless steel welding, preventing carbon</p>	<p>Stainless Steel Ball Transfers (PN 781397) Standard Ball Transfers (PN 781383)</p>  <p>Consists of four rubber wheels and hardware so that it can be mounted into the 12" (30 cm) vee head. 1,000 lb (450 kg) capacity.</p>	<p>Hold-Down Device (PN 781050)</p>  <p>Uses high tensile strength chain for gripping up to 12" (30 cm) pipe onto the large vee head when either welding or using the Max Jax stand for material handling. Chain extension kits are available for pipe up to 40" (101 cm).</p>

Part #	Description	Weight	
		lbs	kg
780260	Big V - Basic	36.0	16.4
781381	Roller Wheel Kit	8.0	3.6
781382	Stainless Steel Sleeves	8.0	3.6
781383	Standard Ball Transfer Kit	8.0	3.6
781394	Rubber Wheel Kit	8.0	3.6

Part #	Description	Weight	
		lbs	kg
781397	Stainless Steel Ball Transfer Kit	5.0	2.3
781407	Stainless Steel Roller Head Kit	8.0	3.6
781050	Hold-Down Device	6.0	2.7

MAX-JAX*

Now Rated at 4,500 lb/2045 kg. Capacity!

The versatile Max-Jax stand is the ideal fabricator stand. The large 12" (30 cm) vee head and heavy duty five-legged design offers the welder a maximum margin of safety on pipe up to 36" (90 cm). With optional accessories, such as the heavy duty casters and Sumner Hold-Down Device,

pipe weighing 4,500 lbs (2,041 kg) per Max-Jax stand can be wheeled with ease from storage rack to welding bay and onto the shipping dock. This means the load is lifted only once, resulting in a reduction of 50% or more in handling costs.

PIPE STANDS

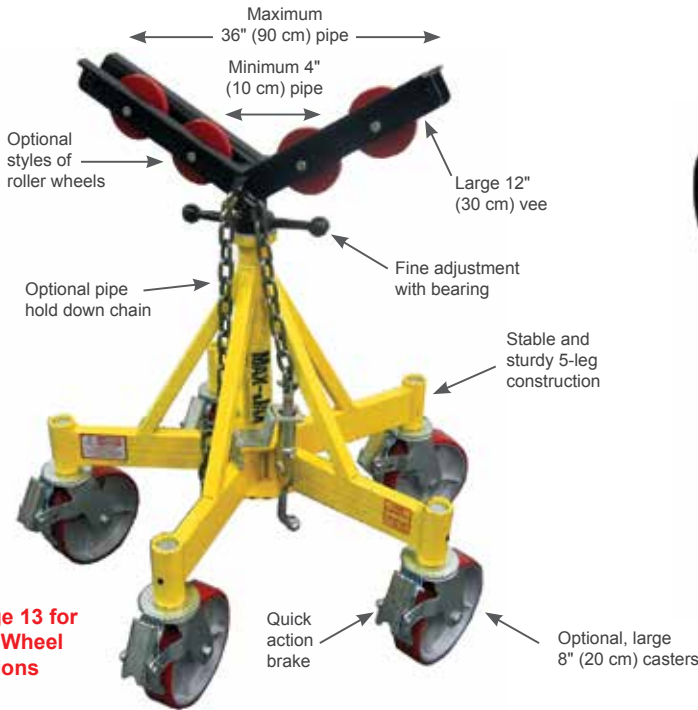

See page 13 for Roller Wheel Options

In the shop or on the job, moving long lengths of pipe is a snap with the Max Jax stand!



Shown with optional Hold-Down Device (Part # 781050)



Max-Jax Kit #1 (Part # 781403)



Max-Jax Kit - Consists of the basic Max-Jax (Part # 781460) with Caster Kit (Part # 781465) and Roller Head Kit (Part # 781406).

Basic Max-Jax (Part # 781460)

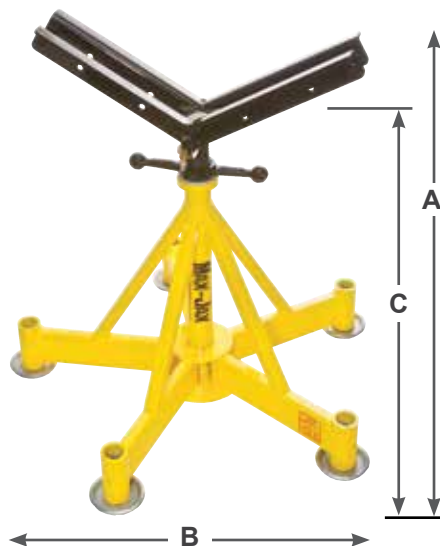







Basic Max-Jax Comes with Large Leveling Pads

The basic Max-Jax stand safely handles large diameter pipe up to 36" (90 cm). The 1-3/4" vee head shaft permits the welder to position loads up to 4,500 lb (2,041 kg) with ease. Check the See Max-Jax accessories on page 13.

Weight - 68.0 lb / 30.8 kg

Large Vee Head Jack Accessories

<p>Roller Wheel Caster Kit (PN 781465)</p>  <p>Max-Jax & Beam Jax Five 8" (20 cm) heavy duty casters make up the Max-Jax Caster Kit. The casters have a quick action braking system.</p>	<p>Stainless Steel Wheel Kit (PN 781407) Capacity 2000 lb/900 kg</p>  <p>Stainless Steel Wheel Kit Provides four roller wheels which can be quickly mounted into the 12" (30 cm) vee head. Roller wheels come in either steel or stainless steel.</p>																																																				
<p>Stainless Steel Sleeves (PN 781382) Capacity 2500 lb/1135 kg</p>  <p>Stainless Steel Sleeves When working with stainless steel pipe, the sleeve option instantly converts the Max Jax to a specialty tool for stainless steel welding, preventing carbon contamination. Used on Max-Jax 2 w/Vee Head.</p>	<p>Roller Wheel Kit (PN 781381) Capacity 2500 lb/1135 kg</p>  <p>Roller Wheel Kit Wide roller wheels provide smoother pipe rotation with less effort.</p>																																																				
<p>Rubber Wheel Kit (PN 781394)</p>  <p>Rubber Wheel Kit Consists of four rubber wheels and hardware so that it can be mounted into the 12" (30 cm) vee head. 1,000 lb (450 kg) capacity.</p>	<p>Stainless Steel Ball Transfers (PN 781397) Standard Ball Transfers (PN 781383)</p>  <p>Consists of four rubber wheels and hardware so that it can be mounted into the 12" (30 cm) vee head. 1,000 lb (450 kg) capacity. Used on Max-Jax 2 w/Vee Head.</p>																																																				
<p>Hold-Down Device (PN 781050)</p>  <p>Uses high tensile strength chain for gripping up to 12" (30 cm) pipe onto the large vee head when either welding or using the Max-Jax stand for material handling. Chain extension kits are available for pipe up to 40" (101 cm).</p>	<table border="1"> <thead> <tr> <th colspan="2"></th> <th colspan="2">Weight</th> </tr> <tr> <th>Part #</th> <th>Description</th> <th>lbs</th> <th>kg</th> </tr> </thead> <tbody> <tr> <td>781394</td> <td>Rubber Wheel Kit</td> <td>8.0</td> <td>3.6</td> </tr> <tr> <td>781397</td> <td>Stainless Steel Ball Transfer Kit</td> <td>5.0</td> <td>2.3</td> </tr> <tr> <td>781407</td> <td>Stainless Steel Roller Head Kit</td> <td>8.0</td> <td>3.6</td> </tr> <tr> <td>781465</td> <td>Roller Wheel Caster Kit (Max-Jax)</td> <td>75.0</td> <td>34.1</td> </tr> <tr> <td>781050</td> <td>Hold-Down Device</td> <td>6.0</td> <td>2.7</td> </tr> <tr> <td>780260</td> <td>Big V - Basic</td> <td>36.0</td> <td>16.4</td> </tr> <tr> <td>781460</td> <td>Max-Jax - Basic</td> <td>68.0</td> <td>30.8</td> </tr> <tr> <td>781403</td> <td>Max-Jax Kit #1</td> <td>144.0</td> <td>65.5</td> </tr> <tr> <td>781381</td> <td>Large Roller Wheel Kit</td> <td>8.0</td> <td>3.6</td> </tr> <tr> <td>781382</td> <td>Stainless Steel Sleeves</td> <td>8.0</td> <td>3.6</td> </tr> <tr> <td>781383</td> <td>Standard Ball Transfer Kit</td> <td>8.0</td> <td>3.6</td> </tr> </tbody> </table>			Weight		Part #	Description	lbs	kg	781394	Rubber Wheel Kit	8.0	3.6	781397	Stainless Steel Ball Transfer Kit	5.0	2.3	781407	Stainless Steel Roller Head Kit	8.0	3.6	781465	Roller Wheel Caster Kit (Max-Jax)	75.0	34.1	781050	Hold-Down Device	6.0	2.7	780260	Big V - Basic	36.0	16.4	781460	Max-Jax - Basic	68.0	30.8	781403	Max-Jax Kit #1	144.0	65.5	781381	Large Roller Wheel Kit	8.0	3.6	781382	Stainless Steel Sleeves	8.0	3.6	781383	Standard Ball Transfer Kit	8.0	3.6
		Weight																																																			
Part #	Description	lbs	kg																																																		
781394	Rubber Wheel Kit	8.0	3.6																																																		
781397	Stainless Steel Ball Transfer Kit	5.0	2.3																																																		
781407	Stainless Steel Roller Head Kit	8.0	3.6																																																		
781465	Roller Wheel Caster Kit (Max-Jax)	75.0	34.1																																																		
781050	Hold-Down Device	6.0	2.7																																																		
780260	Big V - Basic	36.0	16.4																																																		
781460	Max-Jax - Basic	68.0	30.8																																																		
781403	Max-Jax Kit #1	144.0	65.5																																																		
781381	Large Roller Wheel Kit	8.0	3.6																																																		
781382	Stainless Steel Sleeves	8.0	3.6																																																		
781383	Standard Ball Transfer Kit	8.0	3.6																																																		

Max Jax Specifications		
Load Capacity		4,500 lb (1,135 kg)
Basic Unit	A (height)	27.0" (686 mm)
	B (width)	29.6" (752 mm)
Basic Unit w/Casters	(height)	35.5" (927 mm)
	(width)	39.5" (1,033 mm)
Vee Head Height	C (min)	21.0" (533 mm)
	(max)	33.0" (838mm)
Vee Head Height w/Casters	(min)	30.5" (775 mm)
	(max)	42.5" (1,080 mm)

MAX-JAX²



Now Multiple Heights!

The Max-Jax 2 stand has the unique capability of being either a low or high moveable jack stand for 4 - 36" (100 - 915 mm) pipe. By quickly removing the jack head and casters from the base can be rotated from a low to high stand.

US and International Patents Pending.



Max-Jax 2 Base in High Position for Small Diameter Pipe

36"
914 mm



Max-Jax 2 Base in Low Position for Large Diameter Pipe

23"
584 mm

PIPE STANDS

Two Head Styles

Max-Jax 2 Kit with Standard Large Vee Head, Roller Wheels & Caster Stand (PN 786450)



Requires no pipe adjustment.

Max-Jax 2 Kit with Drop Slot Head, Roller Wheels & Caster Stand (PN 786451)



Easy Base Conversion



Remove Head



Remove Polymer Bearing



Remove Casters



Rotate Base



Reattach Head Casters

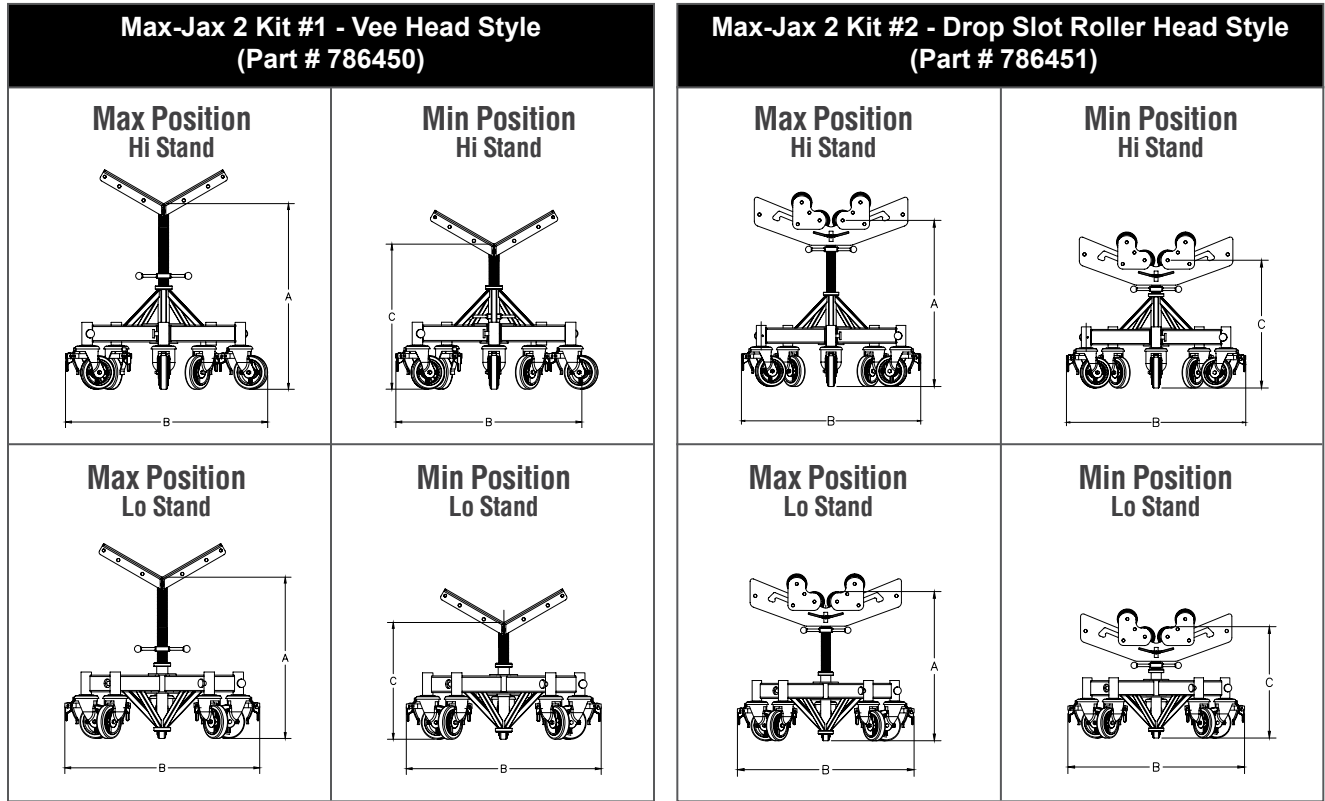

PIPE STANDS

Specifications

Vee Head Style Specifications			
		Inches	mm
HI	A	74	1879.6
	C	61	1549.4
LO	A	52	1320.8
	C	66	1676.4
Width	B	69	1752.6
Load	4500 lb / 2045 kg		

Drop Slot Head Style Specifications			
		Inches	mm
HI	A	26	584.2
	C	34	762.0
LO	A	23	660.4
	C	30	863.6
Width	B	69	1752.6
Load	4500 lb / 2045 kg		

Part #	Description	lb	kg
786450	Max Jax 2 Kit #1 (Vee Head Style) includes Max Jax 2 Basic (PN 781460), Caster Kit (PN 779048), and Vee Head Kit (PN 781417)	106	48.3
786451	Max Jax 2 Kit #2 (Drop Slot Head Style) includes Max Jax 2 Basic (PN 781460), Caster Kit (PN 779048), and Drop Slot Head Kit (PN 781406)	127	57.7

See Optional Roller Head Wheels on Page 13.

BEAM-JAX™

Move beams around the shop safely

- ✓ 2,500 lb (1,135 kg) capacity
- ✓ Clamping device centers load on stand & holds material in place while moving around shop
- ✓ 5-leg base construction ensures stability

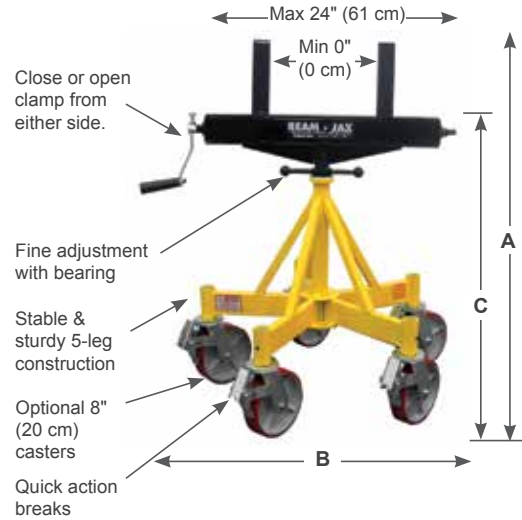

Detachable handle permits easy clamping of material from either side of stand.



Reversible beam forks

Detachable handle can be rotated out of operator's way.

Basic Beam-Jax (Part # 781485)

Used as a stand, the basic Beam-Jax base safely supports 24" (61 cm) beams up to 2,500 lb (1,135 kg).

Specifications		
Load Capacity		2,500 lb (1,135 kg)
Basic Unit	A (height)	27.8" (705 mm)
	B (width)	29.6" (752 mm)
Basic Unit with Casters	(height)	37.3" (947 mm)
	(width)	39.5" (1,003 mm)
Beam Head Height	C (min.)	25.5" (648 mm)
	(max.)	37.5" (953 mm)
Beam Head height with Casters	(min.)	35.0" (889 mm)
	(max.)	47.0" (1,194 mm)

Part #	Description	Weight	
		lbs	kg
781485	Basic Beam-Jax	51.0	23.1
781486	Beam Jax Kit (Beam Jax & Casters)	121.0	54.8



Beam-Jax Kit #1 (Part # 781486)
Includes basic **Beam-Jax Unit (Part # 781485)** & **Caster Kit (Part # 781465)**



**NEWLY
IMPROVED!**

Internal Fit-up Clamp

The Ideal Flange Fit-up Tool!

- ✓ Can be used on all standard weld neck flanges and great with slip-on flanges
- ✓ Contact points stainless steel — a standard feature
- ✓ One piece construction — no loose pieces
- ✓ Quick action operation
- ✓ Now, structurally stronger



8" - 12" (200-300 mm)
Internal Fit-Up Clamp

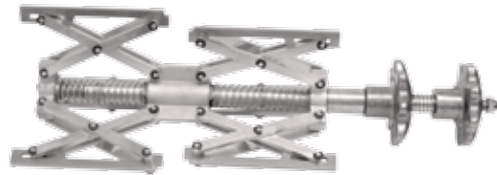

4" - 8" (100-200 mm)
Internal Fit-Up Clamp



2" - 4" (50-100 mm)
Internal Fit-Up Clamp

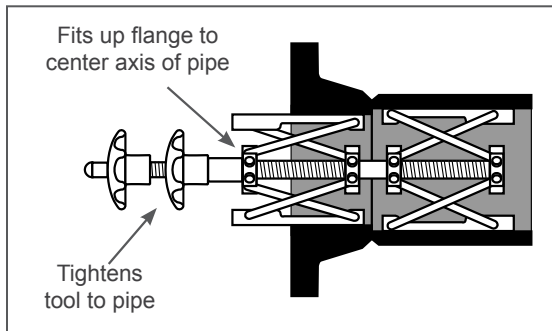

Two independently operated internal mandrels align flange to pipe even if internal dimensions differ.



FIT-UP TOOLS

Simple Operation



1. Tighten jaws to clamp pipe I.D.



2. Mount flange on second set of pipe jaws, adjust for gap and tighten jaws for final fit-up.

Specifications

Part #	Description	Weight	
		lbs	kg
784103	8" - 12" (200-300 mm) Internal Fit-up Clamp	28.0	12.7
784102	4" - 8" (100-200 mm) Internal Fit-up Clamp	8.5	3.9
784100	2" - 4" (50-100 mm) Internal Fit-up Clamp	2.5	1.1

NOTE: The Internal Fit-up Clamp is an alignment tool. A separate lifting device to support the flange weight is recommended.

ULTRA™ *qwik clamp*

**A fast, accurate fit-up
clamp for pipe to pipe,
pipe to fitting...
and more!**

ULTRA* *clamp*

*Ultra Qwik Fit™ clamp
comes with a quick
release push button!*

*Ultra Clamp comes
with standard
threaded adjustment!*



PN 781530
5" – 12"
(127 – 300 mm)

PN 781520
2" – 6"
(50 – 150 mm)

PN 781510
1" – 2-1/2"
(25 – 65 mm)

PN 781130
1" – 2-1/2"
(25 – 65 mm)

PN 781150
2" – 6"
(50 – 150 mm)

PN 781170
5" – 12"
(127 – 300 mm)

US and International Patents Pending.



- ✓ Rugged frame, built for job site use
- ✓ Smooth roller clamping action for positive gripping
- ✓ Stainless steel contacts & alignment screws
- ✓ Operating handle repositions for close work
- ✓ Fine adjustment screws for quick fit-up
- ✓ Light weight for overhead work



Push button design allows for rapid action setting and fine tune threaded adjustment



Pipe to Pipe



Pipe to Fitting



Pipe to Flange



Pipe to Tee

Part #	Description	Weight	
		lb	kg
781130	1 - 2-1/2" Ultra Clamp	4.0	1.8
781150	2 - 6" Ultra Clamp	10.0	4.5
781170	5 - 12" Ultra Clamp	17.0	7.7
781510	1 - 2-1/2" Ultra Qwik Clamp	4.4	2.0
781520	2 - 6" Ultra Qwik Clamp	10.0	4.5
781530	5 - 12" Ultra Qwik Clamp	17.0	7.7

ULTRA™

qwik fit

**A fast, accurate
fit-up clamp for
fitting to fitting!**

ULTRA*

fit



PN 781560
5" – 12"
(127 – 300 mm)

*Ultra Qwik Fit clamp
comes with a quick
release push button!*

PN 781540
1" – 2-1/2"
(25 – 65 mm)

PN 781550
2" – 6"
(50 – 150 mm)

PN 781265
5" – 12"
(127 – 300 mm)

*Ultra Fit clamp comes
with standard
threaded adjustment!*



PN 781275
2" – 6"
(50 – 150 mm)



PN 781265
1" – 2-1/2"
(25 – 65 mm)

US and International Patents Pending.



- ✓ Rugged, compact design to operate in tight locations
- ✓ Stainless steel contacts & alignment screws
- ✓ Two-hand operating handle for positive gripping
- ✓ Fine adjustment screws for quick fit-up
- ✓ Light weight for overhead work
- ✓ Smooth roller clamping action for positive gripping
- ✓ Ultra Qwik Fit quick release button allows clamp to open and close in seconds
- ✓ Push button design allows for rapid action setting and fine tune threaded adjustment

Fit-up two 90° fittings



Fit-up 90° fitting to tee



Part #	Description	Weight	
		lb	kg
781265	1 - 2-1/2" Ultra Fit Clamp	4.0	1.8
781275	2 - 6" Ultra Fit Clamp	8.0	3.6
781285	5 - 12" Ultra Fit Clamp	15.0	6.8
781540	1 - 2-1/2" Ultra Qwik Fit Clamp	4.4	2.0
781550	2 - 6" Ultra Qwik Fit Clamp	10.0	4.5
781560	5 - 12" Ultra Qwik Fit Clamp	15.0	6.8

DX Clamp



Drop Forged Pipe Clamp

- ✓ Tough enough to handle any use or abuse
- ✓ Five models cover 1-14" / 25-350 mm pipe range
- ✓ Adjustment screws offer hardened steel ball contact with pipe

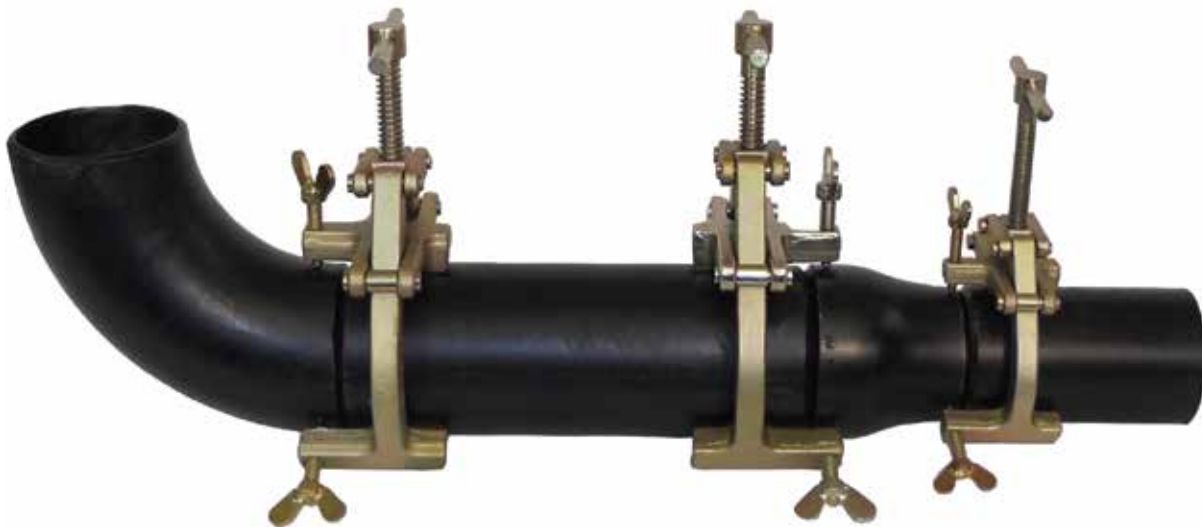

FIT-UP TOOLS

Part #	Product Description	Range	Weight
781570	DX 1-3 Clamp	1-3" / 20-90 mm	3.0 lb / 1.5 kg
781571	DX 2-5 Clamp	2-5" / 50-150 mm	7.3 lb / 3.3 kg
781572	DX 4-7 Clamp	4-7" / 90-190 mm	7.7 lb / 3.5 kg
781573	DX 5-9 Clamp	5-9" / 125-225 mm	14.8 lb / 6.7 kg
781574	DX 10-14 Clamp	10-14" / 225-350 mm	20.0 lb / 9.1 kg

FAB-MATE™

The Hoist for All Fab Shop Needs!

- ✓ 1,000 lb capacity (450 kg), 7 ft (2.1 m) lifting capacity
- ✓ Moves loads vertically and horizontally at the same time
- ✓ Sumner-built single-speed winch offers infinite positioning for accurate fit-ups
- ✓ 8" (20 cm) casters and special base allows load to "get close to the work"
- ✓ Accessories make the Fab-Mate lift extremely versatile
- ✓ Priced for all budgets



Align flanges with Adjust-A-Flange™



Capable of lifting 20' (6.0 m) lengths of 10" (25 cm) pipe

Part #	Description	Height		Width		Length		Weight	
		inch	cm	inch	cm	inch	cm	lbs	kg
783900	Fab-Mate	88.5	224.0	35.0	89.0	44.0	111.0	206.0	93.0

Adjust-A-Fit™

- ✓ Makes lining up fittings a trouble-free, one man operation
- ✓ Uses gravity to align fittings for loads up to 45°
- ✓ Fastens directly onto fittings for loads up to 1,000 lb (450 kg)
- ✓ Threaded shaft assembly is hardened for long tool life
- ✓ Cloverleaf setscrew and threaded shaft handle work from either side

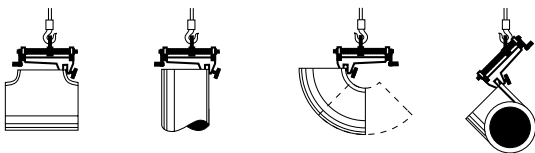

Part #	Description	Weight	
		lbs	kg
780420	ST-104 Adjust-A-Fit	11.0	5.0

Adjust-A-Flange™

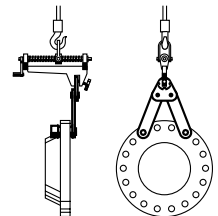

- ✓ Fits all flanges for 5" pipe and larger with bolt holes 3/4 to 1-5/8" (19 to 42 mm)
- ✓ Used in combination with the Adjust-A-Fit™ to bring pipe flanges to exact plumb for tack and weld out
- ✓ Eliminates 75% of the hard work in pipe fitting when used with the Adjust-A-Fit™ and Roust-A-Bout™ devices.
- ✓ Handles loads up to 1,000 lb (450 kg)
- ✓ Flange nuts serve as convenient reference points to check level

Part #	Description	Weight	
		lbs	kg
780425	ST-105 Adjust-A-Flange	11.0	5.0

CLAMP CHAMP™

Pipe Alignment & Clamping Tool

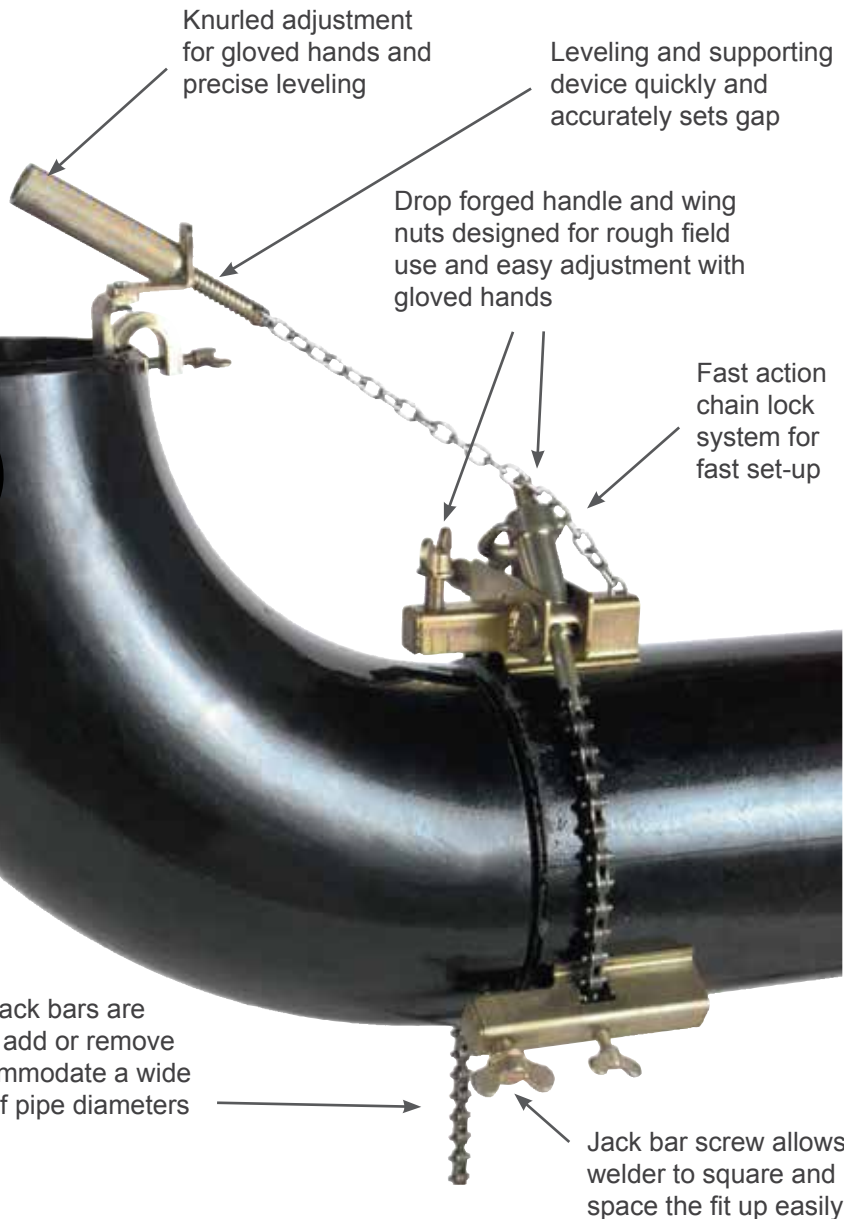

Knurled adjustment for gloved hands and precise leveling

Leveling and supporting device quickly and accurately sets gap

Drop forged handle and wing nuts designed for rough field use and easy adjustment with gloved hands

Fast action chain lock system for fast set-up

All parts plated to resist rust

High tensile strength chain with black oxide finish

Flared jack bars are easy to add or remove to accommodate a wide range of pipe diameters

Jack bar screw allows welder to square and space the fit up easily



CLAMP CHAMP An advanced solution for today's problem fit ups!

The Clamp Champ tool is built for the welder who takes pride in doing his job right the first time. Constructed for years of trouble-free job site use, the versatile Clamp Champ tool makes pipe fit-up simple and accurate – without the need of a helper. The Clamp Champ tool is similar to a pipe vise with fast, easy set up and solid chain engagement.

FIT-UP CAPACITY

- Pipe to Pipe
- Pipe to Fitting
- Pipe to Flange
- Fitting to Fitting

Plus... Reforming up to schedule 40 pipe!

LOW COST

Half the cost of comparable cage clamps

LIGHTWEIGHT CONSTRUCTION

Engineered for strength without the weight

WIDE RANGE

- 1-10" (25–250 mm)
- 1-16" (25–400 mm)
- 10-36" (250–900 mm)
- Carbon or Stainless
- Plus... Conversion Kits to 48" (1,200 mm) pipe!*

Clamp Champ Variety

Each Clamp Champ tool is capable of a wide range of fit-ups without additional accessories.

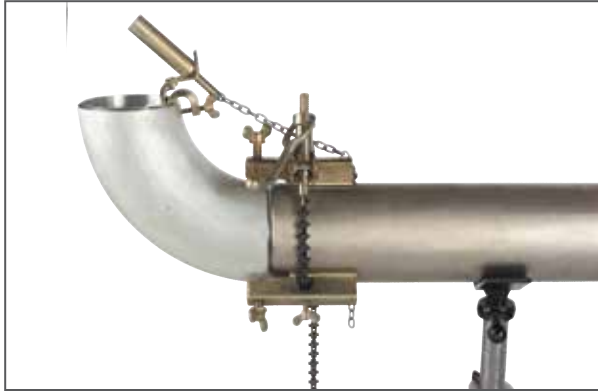

Pipe to 90° Fitting

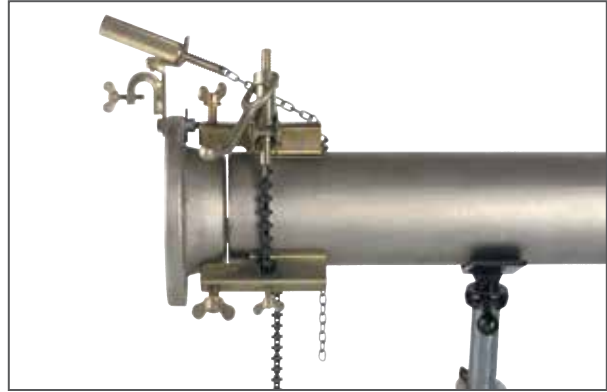

Pipe to Flange

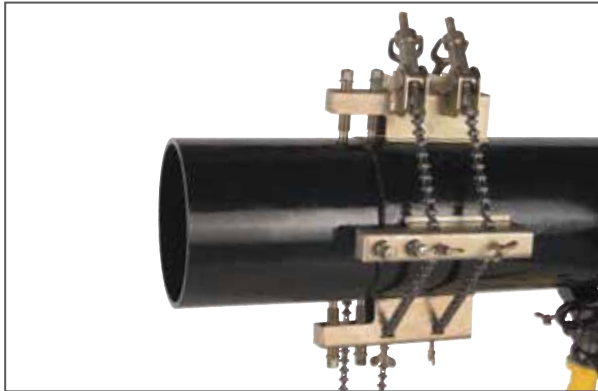

Pipe to Pipe

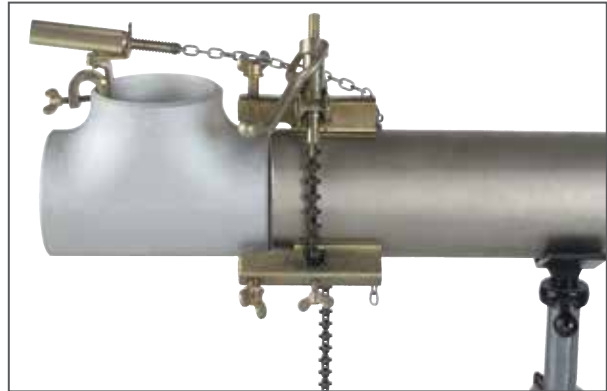

Pipe to Tee

FIT-UP TOOLS

Standard Kit:

Consists of metal carrying box, main block and chain, jack bars and instruction manual. Large Clamp Champ tool includes double jack screws for reforming 20 mm pipe wall.

Range	Model	Part #	Description	Number of Jack Bars	Weight	
					lb	kg
1-10" (25 - 250 mm)	Standard	781000	ST-110 Standard Clamp Champ	3	21.0	9.5
1-10" (25 - 250 mm)	Stainless Steel	780999	ST-210 Stainless Steel Clamp Champ	3	21.0	9.5
1-16" (25 - 400 mm)	Standard	780998	ST-116 Standard Clamp Champ	5	25.0	11.3
1-16" (25 - 400 mm)	Stainless Steel	780997	ST-216 Stainless Steel Clamp Champ	5	25.0	11.3
10-36" (250 - 900 mm)	Standard	781250	Standard Clamp Champ	7	111.0	50.4
10-36" (250 - 900 mm)	Stainless Steel	781251	Stainless Steel Clamp Champ	7	111.0	50.4



Conversion Kit:

Consists of chain and jack bars to increase Clamp Champ capacity

Capacity Increase		Model	Part #	Number of Jack Bars	Chain Length	Weight	
from	to					lb	kg
10" (250 mm)	16" (400 mm)	Standard	781031	2	18" (450 mm)	7.0	3.2
10" (250 mm)	16" (400 mm)	Stainless Steel	781032	2	18" (450 mm)	7.0	3.2
36" (900 mm)	48" (1,200 mm)	Standard	781252	2	30" (760 mm)	16.0	7.3
36" (900 mm)	48" (1,200 mm)	Stainless Steel	781253	2	30" (760 mm)	16.0	7.3



A Professional Fit-Up System For The Fabricator

- ✓ Fit-up 1" to 8" flanges, fittings, reducers, caps and pup joints in amazing time
- ✓ Capable of 300 lb pressure-rated flanges
- ✓ Handles 600 lbs / 270 kg loads
- ✓ Exceptionally accurate
- ✓ Fit and tack 75 to 90 joints during an 8 hour shift
- ✓ Now in stainless steel

With the purchase of each PFAST system, Sumner provides optional in-house set up and training to insure that your team is comfortable in operating and maintaining your PFAST system. Each unit comes complete with all accessories to perform most fit up applications and a mounted electronic tablet that provides a step-by-step pictorial instruction on how each assembly is set up.

Built for years of use, the Sumner PFAST system will quickly help fabricators be the production leader in their industry.



PFAST
(Part # 785450)

US and International Patents.

FIT-UP TOOLS

QUICK FIT-UP OF TOUGH TASKS



Convenient e-tablet Instructions

Each PFAST™ system comes with in-house training by a Sumner representative. In addition, each PFAST system has an electronic tablet attached to the unit that provides a pictorial, step-by-step reference to

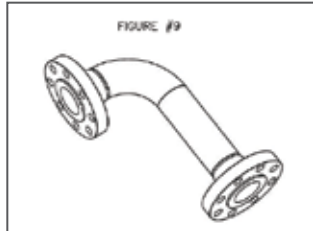

Select Fit-Up



Step 1



Step 2



Step 3

Accessories

Each PFAST (PN 785450) system comes complete with the following accessories:



Tablet



Vee Table - PN 785615



Bed Table - PN 785620



Side Table - PN 785610



Chuck Table - PN 785625



Chuck Adapter Plate
PN 785556



Chuck Nuts - PN 785539



Wedge Support
PN 785630

PFAST Specifications

Minimum Height:	71-1/4" / 181.0 cm	Flange Capacity:	1-8" / DN25-DN200mm, 300 lb pressure rating
Maximum Height:	80" / 203.2 cm	Load Capacity:	600 lbs / 272.0 kg
Width:	30" / 76.2 cm	Carriage Travel:	20-1/4" / 51.4 cm
Length:	60" / 152.4 cm	Bed Length:	45-1/4" / 114.9 cm
Base Weight:	354 lbs / 161.0 kg	Height Stowed:	41-1/4" / 104.8 cm
Shipping Weight (2):	424 lbs / 193.0 kg 225 lbs / 102.2 kg	Handle Cranks per ft/m:	49 / ft 160 / m

PFAST Accessories

Bed Table - PN 785620	12 lbs / 5.5 kg	Vee Table - PN 785615	14 lbs / 6.4 kg
Chuck Table - PN 785625	23 lbs / 10.5 kg	Chuck Table - PN 785625	11 lbs / 5.0 kg
Wedge Support - PN 785630	1 lb / 0.5 kg	Side Table - PN 785610	15 lbs / 6.8 kg
Chuck Plate w/Chuck Nuts PN 785556	20 lbs / 9.1 kg	Storage Box - PN 779928	87 lbs / 39.5 kg



Storage Box
PN 779928

QWIK PINS*

- ✓ Quick installing pins work to level flange (two-hole) for tack and weld-out
- ✓ Hardened tapered Qwik Pin* fasteners automatically center on 5/8" to 1-5/8" (16-42 mm) holes
- ✓ Features Acme threads for maximum clamping power and hardened steel for long-lasting use



For fast, accurate alignment of carbon pipe flanges

Part #	Description	Weight	
		lbs	kg
781235	Qwik Pins	4.0	1.8



Simple Operation:

1. Push spring-loaded button
2. Separate pin from nut
3. Insert into top two flange holes
4. Push spring button and re-insert onto pin
5. Quarter turn to tighten

Welder's Stool

For Fabrication Shops

- ✓ Stamped steel seat with air holes
- ✓ Cozy seat conforms to body even during 8 hour shifts
- ✓ All steel construction
- ✓ Uses Sumner lock washer for quick height adjustment
- ✓ Seat contained to stool – will not come out accidentally
- ✓ 300 lb/135 kg capacity
Max height: 22" / 55.9 cm
Min height: 15" / 38.1 cm



Part #	Description	Weight	
		lbs	kg
785800	Welder's Stool	18.0	8.2

Flange Pins

For accurate alignment of pipe flanges
(carbon or stainless steel)

- ✓ Quick installing pins work as convenient reference points to level flange for tack and weld-out — no tools needed
- ✓ Hardened tapered ST-106 and ST-206 pins automatically center on 5/8" to 1-5/8" (16–42 mm) holes; ST-258 pins similarly set in 1-1/2" to 2-5/8" (38–66 mm) holes or flange thicknesses of 4-5/8" to 6-3/8" (117–162 mm)
- ✓ Features Acme threads for maximum clamping power and hardened steel for long lasting use

Part #	Description	Weight	
		lbs	kg
780430	ST-106 Flange Pins	4.0	1.8
780429	ST-206 Stainless Steel Flange Pins	4.0	1.8
780650	ST-258 Flange Pins	32.0	14.5



ST-106 / ST-206



ST-258



Flange Leveler



- ✓ Now two-hole & level in one time-saving operation
- ✓ Uses push-button Qwik Pin nuts for fast action
- ✓ Features stub Acme threads for maximum clamping & hardened steel for lasting use



- ✓ Automatically centers in flange holes 5/8" to 1-5/8" (16–42 mm)
- ✓ Easily replaceable vials in the event of breakage

Part #	Description	Weight	
		lbs	kg
781240	Flange Leveler	4.5	2.0
779934	Vial Kit	0.5	0.2

Flange SPREADER (Manual)

ST-301



ST-302



ST-303



ST-304



- ✓ 4 models to cover flange ranges from 1" (25 mm) to 24" (600 mm)
- ✓ Can be used for 150 to 1,500 lbs flanges
- ✓ Hardened wedge for safe splitting
- ✓ Large feed screw
- ✓ Drive can be rotated by 1-3/8" wrench or 1/2" (12 mm) bar
- ✓ Compact design – strong enough for tough jobs



Part #	Description	Spread	Pin Diameter	150 lb	300 lb	400 lb	600 lb	900 lb	1,500 lb
784003	ST-301 Flange Spreader	3" (76 mm)	5/8" (16 mm)	1-6"	3/4-4"	1/2-2"	—	—	—
784002	ST-302 Flange Spreader	4" (101 mm)	3/4" (19 mm)	2-12"	1-1/2-8"	1-4"	1-4"	1-2"	1-2"
784001	ST-303 Flange Spreader	5" (127 mm)	7/8" (22 mm)	5-24"	2-1/2-12"	1-1/2-8"	2-6"	1-4"	1-3"
784000	ST-304 Flange Spreader	6-3/8" (162 mm)	1" (25 mm)	10-24"	7-24"	3-1/2-16"	4-10"	1-8"	1-5"

FIT-UP TOOLS

Flange SPREADER (Hydraulic)

Accessories - Part # 777010
Hand hydraulic pump for Flange Spreader with 6' (1.5 m) hose and quick disconnect.



- ✓ 10 ton flange splitter to tackle the tough jobs
- ✓ Spreader arms adjust from 2-3/4" to 8-1/2" 70 mm to 215 mm
- ✓ Spring return, single action cylinder
- ✓ Hardened wedge
- ✓ Simple operation
- ✓ Hand pump and 6' (1.5 m) hose available as accessories

Part #	Description	Capacity	Cylinder Capacity	Cylinder Stroke	Flange Pin Size	150 lb	300 lb	400 lb	600 lb	900 lb	1,500 lb
784004	ST-310 Flange Spreader	9 x 92 mm	10 ton	2" (54 mm)	1-1/4" - 1-5/8" (32-42 mm)	22-42"	16-28"	14-24"	12-20"	8-16"	4-8"

Rotary Ground Clamp

Puts an End to Tangled Ground Leads

- ✓ Rotary head turns with the pipe — puts an end to ground lead twist, tangle and wear
- ✓ Provides quick, positive ground for roll-out welding of pipe and fittings — eliminates weld pinholes caused by poor grounding
- ✓ Attaches and detaches in seconds
- ✓ Makes up ground leads three ways — lug, clamp-on and bare cable
- ✓ Positive anti-arc bearings take loads up to 400 amps

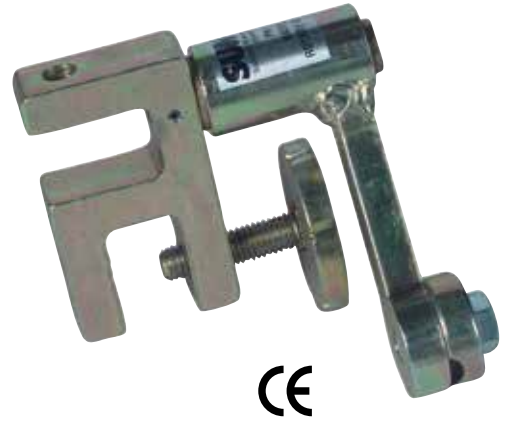

CE

Part #	Description	Amp Capacity	Weight	
			lbs	kg
780435	Rotary Ground Clamp	400	4.0	1.8

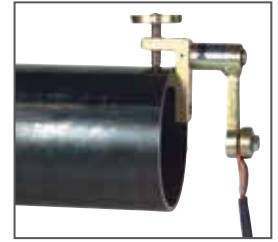

FIT KIT™

Get the Ultra Clamp, the Ultra Fit Clamp, and the Internal Fit-Up Clamp... all in one great package!

Fit Kit 2" – 12" - PN 780315

- Four (4) Fold-A-Jacks
- 2" – 6" Ultra Clamp*
- 5" – 12" Ultra Clamp*
- 2" – 6" Ultra Fit
- 5" – 12" Ultra Fit
- 2" – 4" Internal Fit-Up Clamp
- 4" – 8" Internal Fit-Up Clamp
- 8" – 12" Internal Fit-Up Clamp
- Quad Level
- Aluminum Square
- One set of Qwik Pins* fasteners
- Weldbox 3617

Fit Kit 2" – 6" - PN 780324

- 2" – 6" Ultra Clamp
- 2" – 6" Ultra Fit Clamp
- 4" – 8" Internal Fit-Up Clamp
- Set of carbon steel flange pins
- Quad Level
- Weldbox™ 2008



CE

Part #	Description	Weight	
		lbs	kg
780324	Fit Kit 2" – 6"	35.0	16.0
780315	Fit Kit 2" – 12"	283.9	129.0

Welding Gage

- ✓ Available in both imperial and metric
- ✓ Measure internal hi-lo misalignment and root weld gap spacing



Part #	Description	Weight	
		lbs	kg
781900	Welding Gage - Imperial	0.3	0.1
781901	Welding Gage - Metric	0.3	0.1

Accurate quick check of internal hi-lo

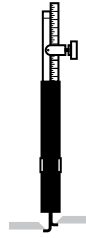

Root weld spacing with little effort

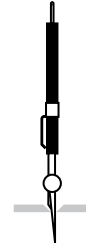

Standard Squares

Standard Squares from Sumner are marked with both imperial and metric units.

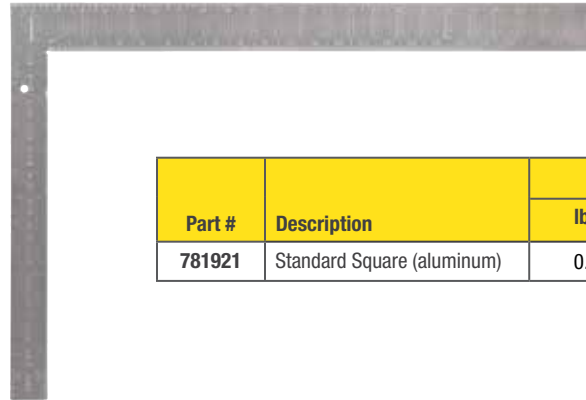

Part #	Description	Weight	
		lbs	kg
781921	Standard Square (aluminum)	0.8	0.4

Aluminum (PN 781921)
Lightweight, resists rust.

FIT-UP TOOLS

Multiple Purpose Magnetic Fixtures

Fit-up is a snap with Sumner's line of magnetic welding fixtures...



Small Angle Fixture
PN 781886



Medium Angle Fixture
PN 781887



Large Angle Fixture
PN 781888



Multiple Angle Fixture

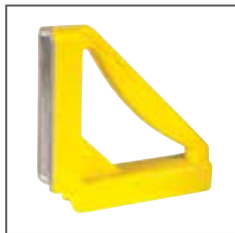

HD Fixed 90° Fixture



Position Square Tubing



Fit-up Round Tubing



Hold Tubing to Steel Plate

Part #	Description	Holding Cap.	Dimensions	Angle Configuration	Weight
781885	Multiple Angle Fixture	28.0 lb (12.5 kg)	3.75" x 0.5" x 2.5" (96 x 14 x 64 mm)	30°, 45°, 60°, 75°, 90°	1.0 lb (0.4 kg)
781886	Small Angle Fixture	48.5 lb (22.0 kg)	4.75" x 0.5" x 3.25" (120 x 14 x 82 mm)	45°, 90°, 135°	1.0 lb (0.4 kg)
781887	Medium Angle Fixture	90.0 lb (41.0 kg)	6.33" x 0.75" x 4.0" (160 x 20 x 102 mm)	45°, 90°, 135°	2.0 lb (0.9 kg)
781888	Large Angle Fixture	122.0 lb (55.0 kg)	7.88" x 0.89" x 5.0" (200 x 22 x 128 mm)	45°, 90°, 135°	3.0 lb (1.4 kg)
781875	Heavy Duty 90° Fixture	88.0 lb (40.0 kg)	8.2" x 8.2" x 1.8" (207 x 207 x 48 mm)	90°	6.0 lb (2.7 kg)

For fast, accurate positioning of flat and round ferrous metal for welding and assembly!

Pocket Level (PN 781947)



A twin vial level constructed of tough ABS and aluminum frame, the strong magnetic base makes this pocket-size level great for many tasks.

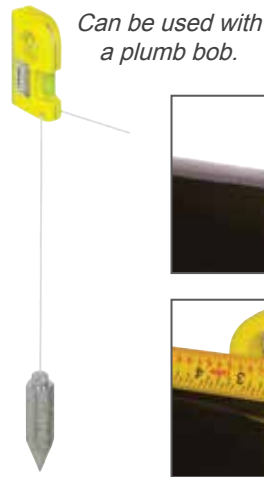

Can be used with a plumb bob.



Level pipe for fit-up

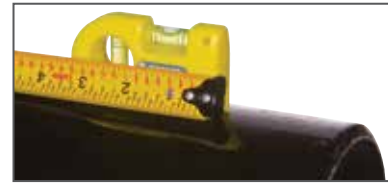

Earth magnet on base and side to hold measuring tape

Quad Level (PN 781946)

This is a tough, anodized aluminum level with a magnetic base and four vials (0°, 30°, 45°, 90°). A "v" cut into the base makes the Quad Level great for pipe and conduit work.



8.5" (21.6 cm) length



ACCU-LEVEL (PN 781950)



- ✓ Rugged die cast aluminum
- ✓ 0°, 45°, 90° acrylic vials
- ✓ Grooved base that fits on pipe and conduit
- ✓ 10" / 25 cm torpedo level
- ✓ .0005"/inch (0.5mm/m) accuracy
- ✓ Earthen magnetic base



Comes with FREE polyester holster!



Part #	Description	Weight	
		lb	kg
781950	Accu-level	.75	.34



Center Punch

(PN 784520)

- ✓ Easy to read digital gage
- ✓ Spring-loaded striking hammer
- ✓ Magnetic base
- ✓ Removable gage with magnetic base
- ✓ 4 - 8" Capacity

Part #	Description	Weight	
		lb	kg
784520	Center Punch	1.85	0.84
779546	Inclinometer	0.6	0.28

Center head with magnetic aluminum base can be used on the circumference of pipe or tanks. Digital gage provides highly visible, accurate reading when establishing a centerline. Built in spring loaded hardened striking pin marks location with the push of a button. Detachable digital gage comes with a magnetic base for additional leveling applications. Plus, digital gage doubles as an angle finder and can be zeroed out during fabrication.



Push Button
spring-loaded



Magnetic base



Alignment indicator



Gage with
magnetic base

Universal Center Punch

(PN 784590)

FIT-UP TOOLS



US and International
Patents Pending

The Sumner Universal Center Punch has arms which are joined and adjust to pipe circumferences from as small as 4" diameter to whatever pipe or tank size you wish to work on. The Universal Center Punch has the same features found on Sumner's Center Punch with unlimited capacity. Magnetic arms attach to the steel surface to assure accurate location when using the punch's spring loaded striking hammer. The center punch comes with a detachable digital gage with a magnetic base for additional leveling applications. The gage can be zeroed out and used as an angle finder during fabrication.

- ✓ Adjustable arms accommodate 4" to any size steel pipe or tank
- ✓ Magnetic base
- ✓ Push button spring loaded striking hammer
- ✓ Removeable digital gage with magnetic base
- ✓ Alignment marks for centering
- ✓ Digital gage can be used as angle finder



Used on 4" pipe

Part #	Description	Weight	
		lb	kg
784520	Center Punch	1.85	0.84
779546	Inclinometer	0.6	0.28



Used on 36" pipe

MUL-T-SQUARE*

Makes Problem Fit-Up Easy & Simple Set-Ups a Snap!

- ✓ Lightweight, but durable
- ✓ Handles up to 8" (20 cm) flanges and up to 14" (35 cm) fittings
- ✓ Versatile for measuring 45° and 90° angles
- ✓ Blades marked with both Imperial and Metric units



The Mul-T-Square tool consists of two 45° blades that slide effortlessly in an industrial-strength plastic handle. Each blade is made of stainless steel for precise alignment. The 10" (26 cm) and 14" (35 cm) arms allow for measurement of tight fit-ups or they can be expanded for up to 30" (76 cm) squaring of 90° fittings. In some instances, the 45° blades are handy by themselves for simple alignment. The blades are loosened or secured by a simple twist of the conveniently located locking knob.

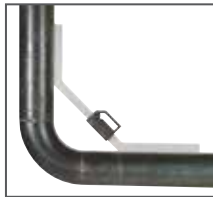

Part #	Description	Weight	
		lbs	kg
790000	Mul-T-Square complete (standard blades)	2.0	0.9
790001	Mul-T-Square handle only	0.3	0.1
790021	Mul-T-Square blades only (pair, standard)	2.0	0.9
790026	Mul-T-Square blades only (pair, extended)	2.5	1.1
790030	Mul-T-Square complete (extended blades)	2.0	0.9

Magnetic Holders (PN 781895)

Sold in packages of three, Sumner Magnetic Holders can be used to position a standard builder's square for layout work or to create an ideal burning guide. Holds squares up to 1/8" (3 mm) thick.

Use with a standard square to create a great torch guide



(PN 781896) Includes 3 magnetic holders and aluminum squares



Part #	Description	Weight	
		lb	kg
781895	Magnetic Holders	1.0	0.4
781896	Magnetic Torch Guide Kit	2.0	0.9

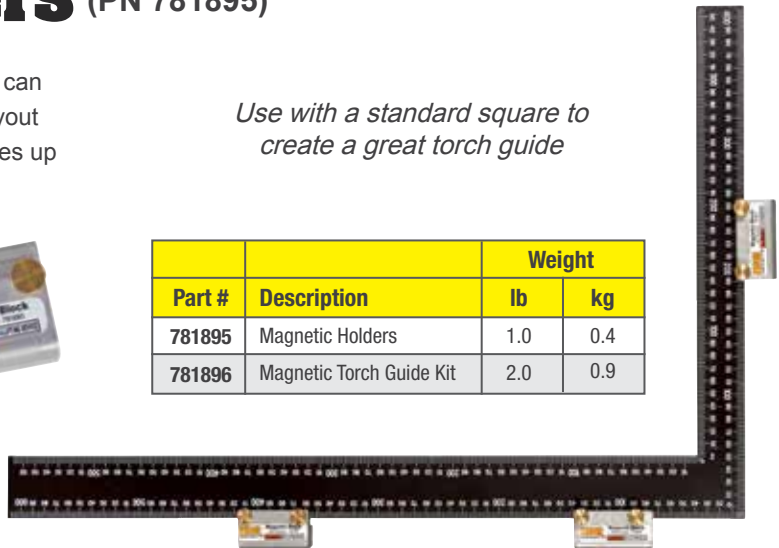

Magnetic Torch Guide Kit (PN 781896)

Kit includes two Sumner Magnetic Holders and a 24" (61 cm) stainless steel cutting rail for straight torch work.



PURGE STAR*

Inflatable Purge Dams 2" - 16" (50 - 400 mm)

- ✓ Purge 6" pipe in less than 3 minutes to less than 1% oxygen content
- ✓ Reduce argon usage
- ✓ Increase weld production rate
- ✓ Improve weld quality

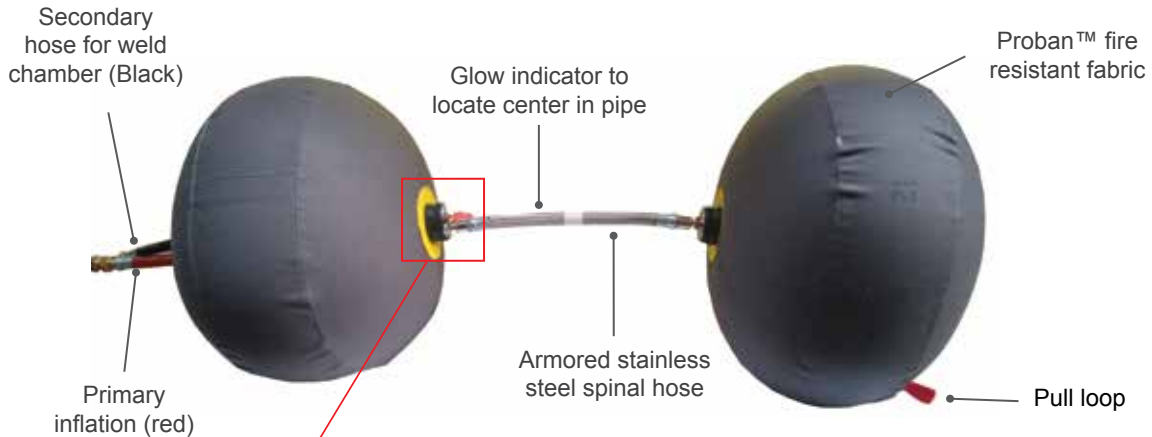

FIT-UP TOOLS

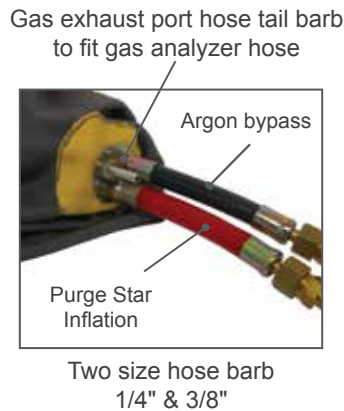
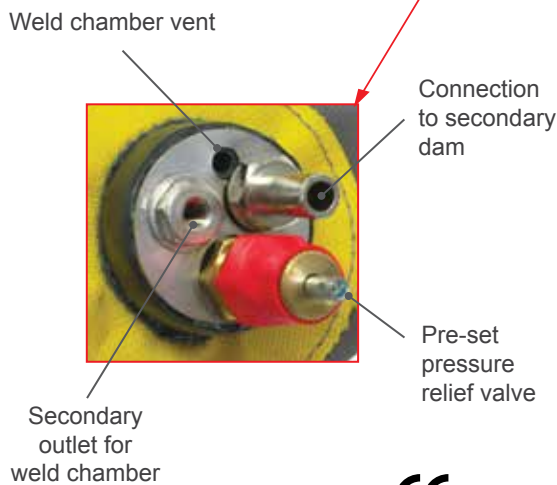

Quick disconnect metal fittings



2" - 10" models have inflation fitting (red)



Part #	Description
Single Hose	
786000	Inflatable Purge Star 2" (50 mm)
786001	Inflatable Purge Star 3" (75 mm)
786002	Inflatable Purge Star 4" (100 mm)
786003	Inflatable Purge Star 6" (150 mm)
786004	Inflatable Purge Star 8" (200 mm)
786005	Inflatable Purge Star 10" (250 mm)
Double Hose	
786006	Inflatable Purge Star 12" (300 mm)
786007	Inflatable Purge Star 14" (350 mm)
786008	Inflatable Purge Star 16" (400 mm)

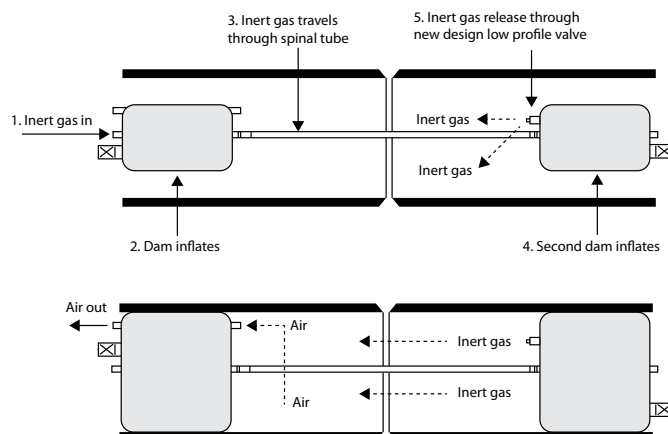

Ring Purge

- ✓ Double hose inflation: Red for dam inflation; Black for weld chamber
- ✓ Exclusive dam dump valve deflates dam quickly after weld is completed
- ✓ High temperature resistant Proban & fire resistant fabrics
- ✓ Purge 36" pipe to less than 1% oxygen content in 10 minutes
- ✓ Dramatic savings in argon
- ✓ High quality weld results
- ✓ Designed for years of use

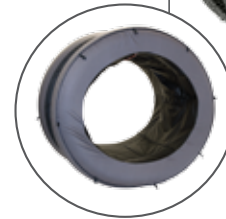

Preset valve fills weld chamber
Argon outlet with diffuser



Centering glow indicator
Chamber vent port

The "open-bore" design of the Ring Purge reduces purge area resulting in less volume of inert gas required.

Part #	Description	Weight	
		lbs	kg
786009	Inflatable Ring Purge 18" (450 mm)	6.0	2.7
786010	Inflatable Ring Purge 20" (500 mm)	6.0	2.7
786011	Inflatable Ring Purge 22" (550 mm)	6.0	2.7
786012	Inflatable Ring Purge 24" (600 mm)	8.0	3.6
786013	Inflatable Ring Purge 26" (650 mm)	8.0	3.6
786014	Inflatable Ring Purge 28" (700 mm)	9.0	4.1
786015	Inflatable Ring Purge 30" (750 mm)	9.0	4.1
786016	Inflatable Ring Purge 32" (800 mm)	12.0	5.4
786017	Inflatable Ring Purge 34" (850 mm)	15.0	6.8
786018	Inflatable Ring Purge 36" (900 mm)	18.0	8.2
786021	Inflatable Ring Purge 42" (1050 mm)	20.0	9.1
786024	Inflatable Ring Purge 48" (1200 mm)	24.0	10.9
786028	Inflatable Ring Purge 56" (1422 mm)	27.0	12.2
786030	Inflatable Ring Purge 60" (1524 mm)	32.0	14.5
786036	Inflatable Ring Purge 72" (1828 mm)	36.0	16.3
786040	Inflatable Ring Purge 80" (2031 mm)	40.0	18.1

Additional sizes available upon request.

Weld Gas Analyzer (PN 779281)

- ✓ Hermetically sealed, robust housing
- ✓ Air and water-tight
- ✓ State of the art electronics
- ✓ High measurement accuracy
- ✓ Quick response time
- ✓ Clear, large display
- ✓ Increased sensor life expectancy

**Accurately Monitor
Oxygen Levels For
Critical Welding
Applications**



Argo-Naught Weld Gas Analyzer Kit Includes: Case, Argo-Naught Analyzer, 2 AA batteries, 6-1/2' (2 m) rubber hose, stainless steel probe & rubber vacuum bulb.

How Weld Gas Analyzers Work:

The Argo-Naught Weld Gas Analyzer accurately monitors oxygen levels while using inert gas to purge stainless steel, titanium and other reactive metal. The Argo-Naught Weld Gas Analyzer measures oxygen content in the weld chamber down to 0.1% (1000 ppm), helps save on argon gas consumption and increases the welder's production rate.

Part #	Description	Weight	
		lbs	kg
779281	Argo-Naught Weld Gas Analyzer	1.3	0.6

Nylon Expansion Plugs

Inexpensive nylon expansion plugs are ideal for low pressure, hydrostatic testing of drains, pools, and spas. The nylon construction and natural rubber rings are resistant to chemicals and seawater corrosion. They are available in 3/4 - 4" (17-100 mm) sizes and come with a hollow shaft with screw cap for sealing or venting.

Sumner expansion plugs are perfect for small pipe diameter purging. The 3/4 - 4" plug kit comes with brass hole barbs for flooding argon into the weld chamber. Plugs are heat tolerant to 100°C / 221°F. Use with gas is not recommended.



FIT-UP TOOLS



Great for purging*



As a pipe plug



Drain stopper



PN 786055 Nylon Expansion Plug Kit

Includes ABS case, foam insert, 2 each 3/4", 1", 1-1/4", 1-1/2", 2", 2-1/2", 3", 3-1/2", 4" plugs and 1 each 10mm and 3/8" barbs.

Shown with PN 784999 Stainless Steel Hold-E Clamp



Comes with hollow shaft



Ideal for purging

PN 780070

6" aluminum expansion plug with hollow shaft – similar to nylon plugs but with aluminum plates.

Specifications

Part #	Inch	mm	Description	Range		Length of Seal		Weight	
				mm	inch	mm	i-nch	oz	gm
786060	3/4	17	Nylon Expansion Plug	18 – 24	0.71 – 0.95	20	0.78	0.35	10
786061	1	25	Nylon Expansion Plug	23 – 32	0.90 – 1.26	25	1	0.70	20
786062	1-1/4	31	Nylon Expansion Plug	31 – 42	1.22 – 1.65	31	1.22	1.24	35
786063	1-1/2	37	Nylon Expansion Plug	37 – 54	1.46 – 2.13	31	1.22	1.59	45
786064	2	50	Nylon Expansion Plug	48 – 65	1.89 – 2.56	30	1.18	2.82	80
786065	2-1/2	60	Nylon Expansion Plug	60 – 77	2.36 – 3.03	32	1.26	4.59	130
786066	3	75	Nylon Expansion Plug	70 – 87	2.76 – 3.43	30	1.18	4.94	140
786067	3-1/2	85	Nylon Expansion Plug	83 – 97	3.27 – 3.82	30	1.18	5.22	148
786068	4	100	Nylon Expansion Plug	95 – 110	3.74 – 4.33	35	1.38	5.65	160
786070	6	150	Aluminum Expansion Plug	148 – 162	5.83 – 6.38	37	1.46	24	680
786055	Nylon Expansion Plug Kit							5.5 lbs	2.5 kg

Maximum Pressure Rating in Steel Pipe		
Size	Bar	PSI
3/4"	5	75
1"	4.5	68
1 1/4"	4	60
1 1/2"	3	45
2"	2	30
2 1/2"	1.5	20
3"	1	15
3 1/2"	.75	12
4"	.6	8
6"	.6	8



Part #	Description	Sizes (inch)	Sizes (mm)
779395	1/--2 BSP x 3/8" Hose Barb	3/4 to 1-1/4	17 to 31
779396	10mm x 1/4" Hose Barb	1-1/2 to 6	37 to 150



Security Storage Chests

- ✓ Tough steel wire mesh
- ✓ Four 6" (15 cm) Heavy Duty casters standard
- ✓ For high visibility storage
- ✓ Reinforced frame & door

NEWLY IMPROVED!

Stor Mac 60



Stor Mac 30

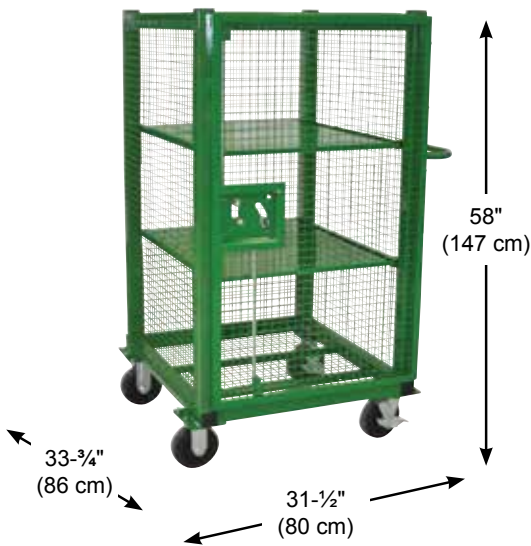

Stor Mac 48



- ✓ Removable shelves
- ✓ Lockable doors
- ✓ Load capacity 1,500 lbs
- ✓ Competitively priced



Two point locking doors use Master Lock No. 5



Part #	Description	Weight	
		lb	kg
784920	Stor Mac Security Storage Chest 60	345.0	156.5
785921	Stor Mac Security Storage Chest 48	310.0	140.6
785920	Stor Mac Security Storage Chest 30	210.0	95.3

CARTS / STORAGE



A Mobile, Heavy Duty Stacking Container for the Contractor

- ✓ Transports 1,500 lb / 680 kg of material
- ✓ Four 6" heavy duty casters
- ✓ Posts for stacking & steering
- ✓ Stacks with other Sumner Stacking Macs
- ✓ Large storage capacity
- ✓ Fits through 36" (91 cm) doorway
- ✓ Lockable casters



Perfect storage for...

- Power cords
- Fittings
- Fasteners
- Safety Gear
- Hardware
- Loose parts
- Pumps & hoses
- Rope Slings and more!

Stacking saves valuable floor space while still allowing access to the bottom Tainer Mac container



Part #	Description	Height		Width		Length		Weight	
		inch	cm	inch	cm	inch	cm	lb	kg
784990	Tainer Mac	24	61	32	81	56	142	200	90.7

CARTS / STORAGE

HANGER MAC™



- ✓ Improve productivity by transporting from shop to site
- ✓ Eliminate multiple handling and reduce fabrication transport costs
- ✓ Available with or without wire mesh base
- ✓ Works well with laser installation systems
- ✓ Stacks with other Sumner Mac carts



Hanger Mac II pictured here.

- Hanger Mac container holds 40 6-8" and 120 2-4" pipehangers
- Folds for compact storage



Dimensions	Height	Width	Length	
Stored	26" / 66 cm	33" / 83.8 cm	58.5" / 148.6 cm	
Operational	68.8" / 174.6 cm	33" / 83.8 cm	58.5" / 148.6 cm	
Part #	Description		lbs	kgs
785650	Hanger Mac I without mesh base		192.0	87.3
785651	Hanger Mac II with mesh base		206.0	93.6
Load Capacity	1,000 lbs / 450 kg			

Bundle MAC™

- ✓ Holds large bundles of conduit
- ✓ Arms fold in seconds for convenient storage
- ✓ 1,000 lb (455 kg) load capacity
- ✓ Stacks with all Mac Carts

Arms fold easily with plunger pins release



Patent Pending



Stacking
MAC
RACKS™



Part #	Description	Dimensions			Weight	
		Width	Height	Length	lb	kg
783320	Bundle Mac	33" (83.8 cm)	42-1/2" (107.9 cm)	58-1/2" (148.6 cm)	165	74.8

PIPE MAC™

A Mobile Pipe Cart

- ✓ Transports 2,000 lb (900 kg) of pipe, individually or up to a height of 34" (86 cm)
- ✓ Center-positioned casters makes rolling the Pipe Mac cart easy and enables quick cart rotation for tight turns
- ✓ Six 6" (15 cm) heavy duty casters



PN 783230

Pipe Mac cart comes with vee attachment. Shown transporting 20" (51 cm) pipe.

Stacking MAC RACKS™



Stacks when not in use



Posts pull out for compact storage

Vee Attachment Included!

Simple but rugged attachment prevents pipe from rolling while the Pipe Mac is in motion.

Easily slips over the four post holders — no tools required!



Specifications	inch	cm
Height (stowed)	19.5	49.5
Height (operating)	44.0	111.7
Length	58.5	148.6
Width	33.0	83.8
Ground clearance	7.5	19.4
Post Height	34.0	86.4

MAGRACK I™



Patent Pending

- ✓ 1,000 lb (455 kg) load capacity
- ✓ Double wall square tubing
- ✓ Eight bins of storage
- ✓ Arms fold easily with plunger release

Stacking MAC RACKS™



MAGRACK II™



Patent Pending

Convenient utility tray.



Support masts nest into base by pulling plunger pins. Folds up in seconds for convenient storage.



Part #	Description	Weight	
		lb	kg
783230	Pipe Mac	170	77.1
783317	Mac Rack I - complete with casters	165	74.8
783299	Mac Rack II - complete with casters	172	78.0

Specifications	With casters	
	inch	cm
Height Stowed	17-3/4	45.0
Height Open	61-1/2	155.6
Length	58-1/2	148.6
Width	33	83.8
Ground Clearance	7-1/2	19.1

The ideal storage chest for all welders!

Weldbox 3617
PN 779928



Weldbox 2812
PN 779911



Weldbox 2008
PN 779910



- ✓ Two-point latching system requires only 1 lock
- ✓ 16 gage steel

PN 779037 Caster Kit
Mount Heavy duty caster on Weldbox 3617 to easily move around the shop.



Part #	Description	Opened Height		Height		Width		Depth		Weight	
		inch	cm	inch	cm	inch	cm	inch	cm	lbs	kg
779910	WELDBOX 2008	16"	41	9-1/2"	24	20-1/8"	51	8-1/2"	22	12.1	5.5
779911	WELDBOX 2812	22-5/8"	57	11"	28	28-3/8"	72	12"	30	30.8	14.0
779928	WELDBOX 3617	35"	89	22-1/2"	57	36"	91	17"	43	97.9	44.5
779037	Caster Kit (WELDBOX 3617)	N/A								23.0	10.4

HANDi-BENCH

A portable welding table

- ✓ Tough #9 expanded metal top
- ✓ 600 lb (270 kg) load capacity
- ✓ 1" (2.5 cm) square tube frame
- ✓ One piece construction
- ✓ 24" x 40" (60 x 100 cm) work surface
- ✓ Table top plated for ground clamp

Built-in torch holder



Use occasionally or as a permanent work bench.



Four-point leg contact

Part #	Description	Work Dimension			Load Capacity	Weight	
		Height	Depth	Length		lb	kg
783980	HB-604 Welding Table	36.3" (92.2 cm)	24.4" (62 cm)	40.4" (102.6 cm)	600 lb (270 kg)	54.0	24.5
783965	8" Wheel Kit for Series 600 Handi-Bench					5.0	2.3



Cricket*

More than a Pipe Buggy!

- ✓ Transport 20 ft (6.1 m) pipe lengths up to 1,000 lbs (450 kg)
- ✓ Comes with ratchet hold-down strap and 16" (41 cm) tubed or flat free tires
- ✓ Weighs only 82 lb (37.2 kg) and can be shipped via UPS
- ✓ Quick handle disconnect for compact storage
- ✓ Carries up to 12" (30 cm) diameter pipe
- ✓ Ideal job-site material carrier

NOW Available with Flat Free Tires



Uses leverage to lift pipe!

Patented



1 Use ratchet to secure Cricket to pipe



2 Use handle to flip Cricket & pipe



3 Reposition handle



Great for flanges, fittings and valves

Part #	Description	Height		Width		Width Between Wheels		Length		Weight	
		inch	cm	inch	cm	inch	cm	inch	cm	lbs	kg
782699	Cricket	21	53	28	71	16	41	28	71	82	37.2
782685	Cricket with Flat Free Tires	21	53	28	71	16	41	28	71	82	37.2

Grasshopper™

Texas Pipe Dolly

- ✓ Special sliding chain block design accommodates long and short loads
- ✓ Carries up to 20" diameter pipe, tool boxes, fittings and valves



Enables one man to lift 2,000 lbs. (900 kg) unassisted!

Specifications										Load Capacity							
Part #	Description	Weight		Length		Width		Height		Weight		Length		Width		Height	
		lb	kg	ft	cm	in	cm	in	cm	lb	kg	ft	cm	in	cm	in	cm
780351	ST-401 Grasshopper	165	75	12	366	35	89	40	102	2,000	900	20	610	20	51	28	71

WELDING CYLINDER CARTS

- Small Single
- Heavy Duty Single
- Small-Medium High Rail
- Medium Range High Rail
- Full Range High Rail



Small Single Cylinder Cart (Model #108)

	Part #	782375
	Model #	108-8S
	Cylinders	40 cf. Acetylene OR 50 to 80 cf Oxygen
	Wheel PN	779024
	Wheel Type	8" semi-pneumatic
	Chain/Bar	Chain
	Lifting Eye	No
	Firewall	No
	Height	40.0" (101.6 cm)
	Depth	12.3" (31.2 cm)
	Width	12.1" (30.7 cm)
	lbs	11.0
kg	5.0	

HD Single Cylinder Cart (Model #112)

	Part #	782386	782385
	Model #	112-10P	112-10S
	Cylinders	75 cf. Acetylene OR 80 to 150 cf Oxygen	
	Wheel PN	779027	779011
	Wheel Type	10" pneumatic	10" semi-pneu.
	Chain/Bar	Chain	
	Lifting Eye	No	
	Firewall	No	
	Height	49.4" (125.5 cm)	
	Depth	18.1" (46.0 cm)	18" (45.7 cm)
	Width	20.8" (52.8 cm)	19.1" (48.6 cm)
	lbs	30.0	36.0
kg	13.6	16.4	

Base Plate: 7" x 14" (178 x 356 mm) Load Capacity: 500 lbs (225 kg)

Small-Med High Rail Cylinder Carts (Model #207)

	Part #	782359	782360
	Model #	207-10S	207-8S
	Cylinders	40 cf. Acetylene & 50 to 80 cf Oxygen	
	Wheel PN	779011	779031
	Wheel Type	10" semi-pneu.	8" semi-pneu.
	Chain/Bar	Chain	
	Lifting Eye	No	
	Firewall	No	
	Height	40.625" (103.2 cm)	
	Depth	11.125" (28.26 cm)	
	Width	16" (40.64 cm)	
	lbs	30.0	30.0
kg	13.6	13.6	

Base Plate: 7.5" x 15.5" (190 x 394 mm)

Small-Med High Rail Cylinder Carts (Model #208)

	Part #	782380	782379
	Model #	208-10S	208-8S
	Cylinders	75 cf. Acetylene & 80 to 150 cf Oxygen	
	Wheel PN	779011	779031
	Wheel Type	10" semi pneu.	8" semi-pneu.
	Chain/Bar	Chain	
	Lifting Eye	No	
	Firewall	No	
	Height	49.5" (125.7 cm)	
	Depth	23" (58.4 cm)	22" (55.9 cm)
	Width	18.3" (46.4 cm)	
	lbs	40.0	40.0
kg	18.1	18.1	

Base Plate: :

Medium Range, High Rail Cylinder Cart w/ Chain (Model #209)

<p>782424 209-14S</p>	Part #	782424	782420	782422	782426	782428
	Model #	209-14S	209-10S	209-10P	209-16P	209-16F
	Cylinders	244 to 330 cf Oxygen & 145 cf Acetylene				
	Wheel PN	779028	779011	779027	779107	779104
	Wheel Type	14" semi-pneu.	10" semi-pneu.	10" pneumatic	16" pneumatic	16" flat free
	Chain/Bar	Chain				
	Lifting Eye	No				
	Firewall	No				
	Height	43.6" (110.7 cm)				
	Depth	16.9" (42.9 cm)			18.27" (46.4 cm)	
	Width	28" (71 cm)			32.5" (82.6 cm)	
	lbs	47	48	40	53	54
	kg	21.4	21.8	18.2	24.1	24.5

Base Plate: 9" x 18" (229 x 457 mm)

Medium Range, High Rail Cylinder Cart w/ Bar (Model #209)

<p>782425 209-14SB</p>	Part #	782425	782421	782427
	Model #	209-14SB	209-10SB	209-16PB
	Cylinders	244 to 330 cf Oxygen & 145 cf Acetylene		
	Wheel PN	779028	779011	779107
	Wheel Type	14" semi-pneu.	10" semi-pneu.	16" pneumatic
	Chain/Bar	Bar		
	Lifting Eye	No		
	Firewall	No		
	Height	43.6" (110.7 cm)		
	Depth	16.9" (42.9 cm)		18.27" (46.4 cm)
	Width	28" (71 cm)		32.5" (82.6 cm)
	lbs	48	49	54
	kg	21.8	23.3	24.5

Base Plate: 9" x 18" (229 x 457 mm)

Medium Range, High Rail Cylinder Cart w/ Lifting Eye & Firewall (Model #209)

<p>782443 209-16PB-LF</p>	Part #	782443	782444	782439
	Model #	209-16PB-LF	209-16FB-LF	209-14SB-LF
	Cylinders	244 to 330 cf Oxygen & 145 cf Acetylene		
	Wheel PN	779107	779104	779028
	Wheel Type	16" pneumatic	16" flat free	14" semi-pneu.
	Chain/Bar	Bar		
	Lifting Eye	Yes		
	Firewall	Yes		
	Height	66" (167.6 cm)		
	Depth	18.4" (46.7 cm)		17" (43.2 cm)
	Width	32.4" (82.3 cm)		27.5" (69.9 cm)
	lbs	75.5	74	81
	kg	34.2	33.6	36.7

Base Plate: 9" x 18" (229 x 457 mm)

** Lifting eye carts comply with ASME B30.20, AWS D14.1 and AISC codes.

*** Fire-rated wall complies with OSHA 1926.350 & OSHA 1910.253.

Full Range, High Rail Cylinder Cart w/ Chain (Model #213)

	Part #	782480	782475	782482
	Model #	213-14S	213-25W	213-16P
	Cylinders	244 to 330 cf Oxygen & 210 to 420 cf Acetylene		
	Wheel PN	779028	782575	779107
	Wheel Type	14" semi-pneu.	25" steel	16" pneumatic
	Chain/Bar	Chain		
	Lifting Eye	No		
	Firewall	No		
	Height	44.6" (113.3 cm)		
	Depth	20.3" (51.6 cm)	26.75" (67.9 cm)	22.1" (56.1 cm)
	Width	31.8" (80.8 cm)	33.6" (85.4 cm)	36.5" (92.7 cm)
	lbs	53	69	59
kg	24	31.3	26.8	

Base Plate: 13" x 25" (330 x 630 mm)



782475
213-25W



782482
213-16P

Full Range, High Rail Cylinder Cart w/ Bar (Model #213)

	Part #	782483
	Model #	213-16PB
	Cylinders	244 to 330 cf Oxygen & 210 to 420 cf Acetylene
	Wheel PN	779107
	Wheel Type	16" pneumatic
	Chain/Bar	Bar
	Lifting Eye	No
	Firewall	No
	Height	44.6" (113.3 cm)
	Depth	22.1" (56.1 cm)
	Width	36.5" (92.7 cm)
	lbs	61
kg	27.7	

Base Plate: 13" x 25" (330 x 630 mm)



782495
213-16PB-LF



782497
213-25PB-LF



782476
213-25WB-LF



782491
213-14SB-LF

Full Range, High Rail Cylinder Cart w/ Lifting Eye & Firewall (Model #213)

	Part #	782496	782495	782497	782476	782491
	Model #	213-16FB-LF	213-16PB-LF	213-25PB-LF	213-25WB-LF	213-14SB-LF
	Cylinders	244 to 330 cf Oxygen & 210 to 420 cf Acetylene				
	Wheel PN	779104	779107	780521	782575	779028
	Wheel Type	16" flat free	16" pneumatic	25" pneumatic	25" steel	14" semi-pneu.
	Chain/Bar	Bar				
	Lifting Eye	Yes				
	Firewall	Yes				
	Height	66.5" (168.9 cm)				
	Depth	22.1" (56.1 cm)		27.1" (68.8 cm)	26.75" (67.9 cm)	20.5" (52.1 cm)
	Width	36.8" (93.5 cm)			33.6" (85.4 cm)	31.8" (80.8 cm)
	lbs	109	109	152	115	103
kg	49.4	49.4	69.1	52.2	46.7	

Base Plate: 13" x 25" (330 x 630 mm)

How To Read Sumner Cylinder Cart Product Descriptions

X X X - X X X X - X X

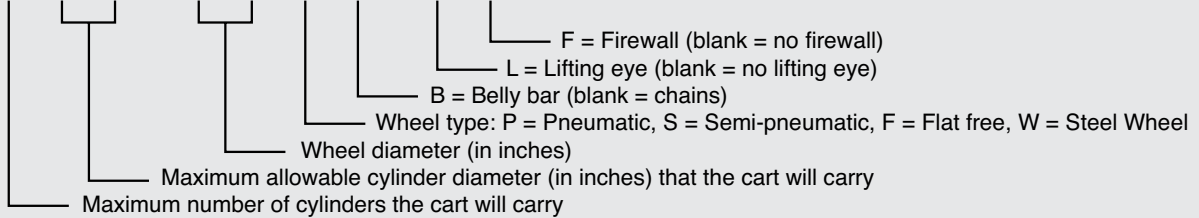

EXAMPLE: Cart Part # 782496, 213-16FB-LF 2 = carries two cylinders
13 = 13 inch maximum cylinder diameter
16 = 16 inch wheel size
F = Flat free tire
B = Belly bar
L = Lifting eye
F = Firewall

Wheel					
Part #	779024	779031	779011	779027	779028
Diameter	8" (200 mm)	8" (200 mm)	10" (250 mm)	10" (250 mm)	14" (355 mm)
Width	1.75" (44 mm)	2" (50 mm)	2.75" (70 mm)	3.5" (89 mm)	1.75" (44 mm)
Bore	0.5" (13 mm)	0.5" (13 mm)	5/8" (16 mm)	5/8" (16 mm)	5/8" (16 mm)
Bearing	Powder metal bushing	Steel bushing	Bronze bushing	Bronze bushing	Bronze bushing
Description	Semi-pneumatic	Semi-pneumatic	Semi-pneumatic	Pneumatic	Semi-pneumatic
Load Capacity	80 lbs (36.2 kg)	400 lbs (180 kg)	400 lbs (180 kg)	350 lbs (150 kg)	150 lbs (65 kg)
Fits Sumner Cart(s)	108, 207, 208	207, 208	112, 207, 208, 209	112, 209	209, 213

Wheel				
Part #	779104	779107	780521	782575
Diameter	16" (400 mm)	16" (400 mm)	25" (635 mm)	25" (635 mm)
Width	4.8" (120 mm)	4.8" (120 mm)	4" (100 cm)	2" (50 mm)
Bore	1" (25 mm)	1" (25 mm)	1.25" (32 mm)	1.25" (32 mm)
Bearing	Powder metal bushing	Powder metal bushing	Bronze bushing	Bronze bushing
Description	Flat free	Pneumatic	Pneumatic	Steel
Load Capacity	380 lbs (170 kg)	380 lbs (170 kg)	800 lbs (360 kg)	800 lbs (360 kg)
Fits Sumner Cart(s)	209, 213	209, 213	213	213

SUMNER

 A Southwire Company

Sumner Manufacturing Co., LLC

USA

7514 Alabonson Road
Houston, Texas 77088
phone: 281.999.6900
fax: 281.999.6966

CANADA

75 Saltsman Drive, Unit 5
Cambridge, ON N3H 4R7
phone: 519.653.5300
fax: 519.653.5305

NETHERLANDS

Midden Engweg 21
NL-3882TS Putten
Netherlands
europeansales@sumner.com
phone: +31 (0) 85 489 0284

UNITED KINGDOM

Unit 3 Kempton Road
Keytec 7 Business Park
Pershore, Worcestershire
WR10 2TA, UK
phone: (44) 01386 556278
fax: (44) 01386 556776

For a full range of Material Lifts & Gantries see Sumner's Lift Catalog.

www.sumner.com