



Event Staging and Seating



AS2100 Aluminum Staging



ST8100 Steel Multi-Stage



308 Tip Up Bleacher



308 Bleacher



Elite Bleachers

CONTENTS

Event Staging

AS2100 Aluminum Staging

- » Features and benefits 4
- » AS 2100 Deck Sections / Storage Carts 5
- » AS2100 Packages / Accessories / Braces 6
- » AS 2100 Legs / Foot Pads 7
- » AS2100 Guard Rail / Understructure 8
- » Truss Understructure 9

ST8100 Multi-Stage

- » Features and benefits 9
- » ST8100 Deck Sections / Storage Carts 10
- » ST8100 Legs / Base / Accessories 11
- » Guard Rail / Bracing / Build Up Frames 12

Stair Units

- » Adjustable / Free Standing / Fixed 13

Ramps

- » Ramps and ADA Compliance Parts 14

Event Seating

308 Bleacher Seating

- » Elevations 16-17
- » Seating / Bases 18
- » Walkway / Stairs / Aisle Components 19
- » Frames / Braces 20
- » Guard Rail Panels / Posts 21

Elite Bleachers

- » 4-Row Steel 22
- » 5-Row Steel 22

Crowd Control Barrier

23

AB Elite Grandstands

23



Image Courtesy of PFA Productions



Image Courtesy of JoRonCo Rentals



Image Courtesy of JoRonCo Rental

**E
v
e
n
t
S
t
a
g
i
n
g**



Presenting Aluminum Staging

AS 2100 FEATURES AND BENEFITS

The AS 2100 Staging System is an aluminum stage designed for ease of use and durability. Available in a variety of shapes and dimensions with unique locking hooks; your options for configurations are endless.

- Minimal parts required
- Quick snap-in legs and guard panels
- Interlocking hook design eliminates cam locks
- Stairs / legs interchange with Multi-Stage ST8100
- Extremely versatile for indoor or outdoor use



Image courtesy of PFA Productions

- Easily adaptable for risers
- Shared legs reduces the number of components
- Meets or exceeds all IBC and UBC code requirements
- All parts replaceable
- The understructure combines simplicity and strength.
- For higher elevations a ring system understructure is available

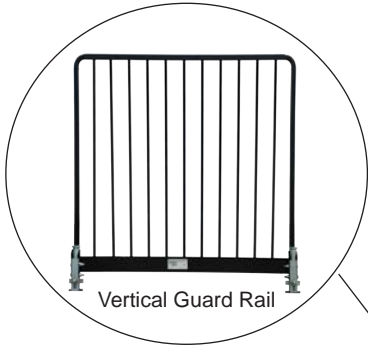

Vertical Guard Rail



Ultra-Stair

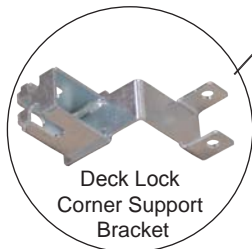
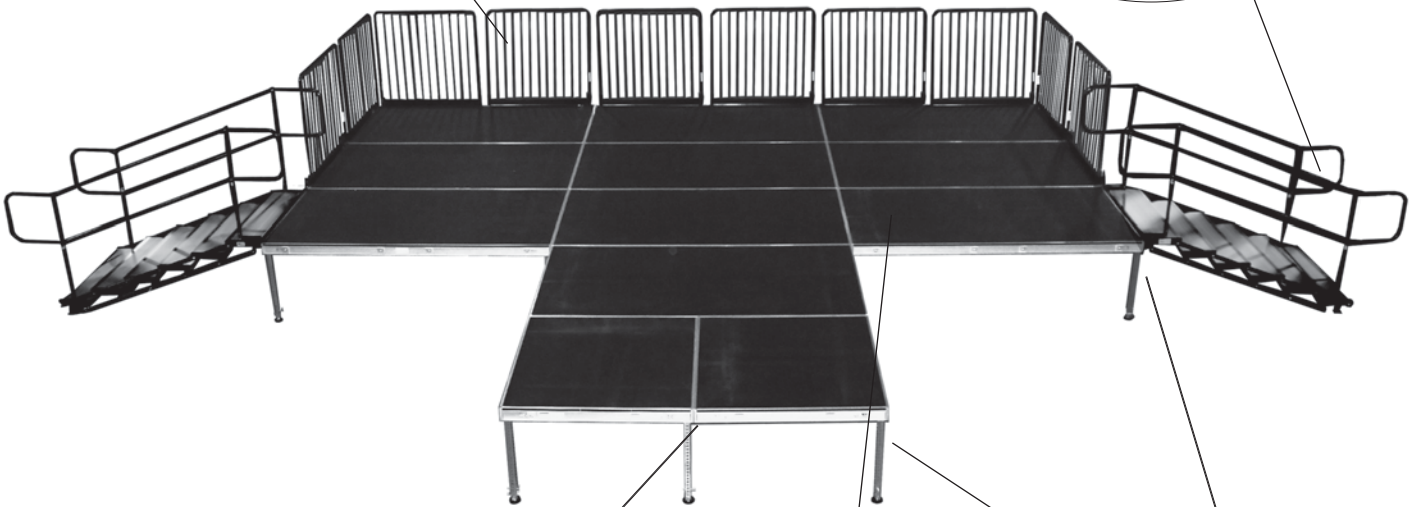

Deck Lock Corner Support Bracket

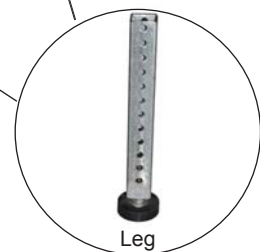

Leg

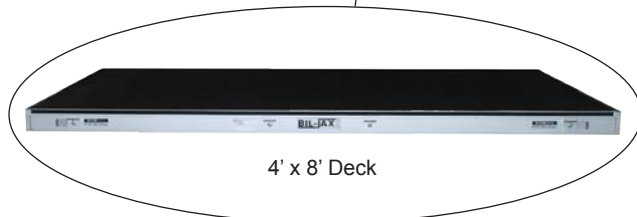

4' x 8' Deck

AS 2100 Deck Sections / Storage Cart

Decking

Standard deck sizes for the AS 2100 include 4' x 4', 4' x 8', 45° corner, and rounded corner decks. The decks are designed for 1 3/4" fixed legs or telescopic legs. All leg styles attach to decks with the use of thumbscrew eliminating snap pins. All decking includes velcro for skirting.

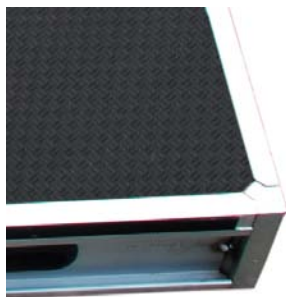

Deck surface options include:
HDPE = High Density Polyethylene

Part Number	Description	Weight
C105-20-7	4' x 8' Black poly ripple HDPE aluminum deck	132
C105-22-7	4' x 4' Black poly ripple HDPE aluminum deck	71
C105-26-7	2' x 2' Black poly ripple HDPE aluminum deck	18
C105-34-7	2' x 4' Black poly ripple HDPE aluminum deck	46
C105-32-7	2' x 8' Black poly ripple HDPE aluminum deck	70
C105-27-7	1/4 Round 4' x 4' black poly ripple HDPE aluminum deck	32
C105-29-7	45° 4' x 4' Black poly ripple HDPE aluminum deck	32
0105-01-04	Deck Lock - Corner Support Bracket	1

*Other deck surfaces available upon request. Contact factory

Possible Configurations:

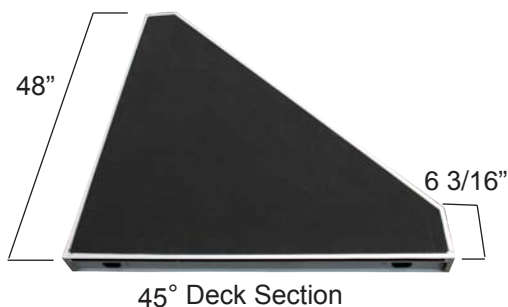
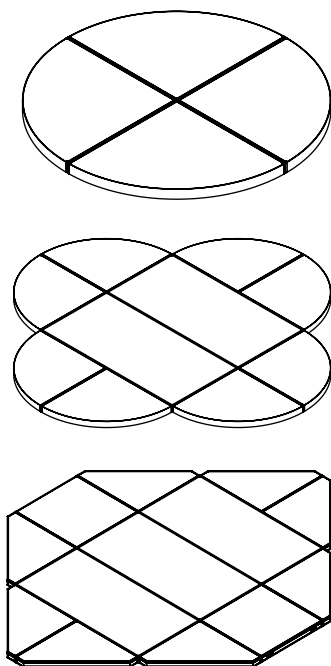

Our product features genuine VELCRO® brand fasteners to attach skirting

Storage Cart

The AS2100 storage cart makes storage and handling of your decking and accessories easy. Carts are adjustable to fit 8 4' decks or 8 8' decks with additional storage for legs and other accessories.



Part Number	Description	Weight
0105-25-32	Adjustable Stage Cart - 4' to 8' adjustment	105

AS2100 Cart Packages / Accessories / Bracing

Cart Packages

Cart packages can fit through a standard doorway (up to 33"). Swivel and locking casters as well as fork lift pockets are included.



art Number	Description	Weight
105-100-01	4' x 4' Cart package (includes 8 4' x 4' poly decks, 18 12" fixed legs with footpad, 18 24" fixed legs with footpad, 1 storage cart)	832
105-100-02	4' x 8' Cart package (includes 8 4' x 8' poly decks, 18 12" fixed legs with footpad, 18 24" fixed legs with footpad, 1 storage cart)	1000

Possible Configurations:

1 - 4' x 4' Package

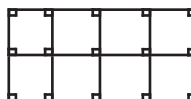

8' x 16'

2 - 4' x 4' Packages

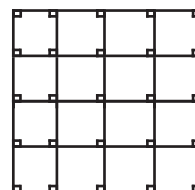

16' x 16'



4' x 8' Cart package
0105-100-02

Possible Configurations:

1 - 4' x 8' Package

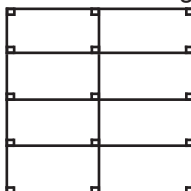

16' x 16'

2 - 4' x 8' Packages

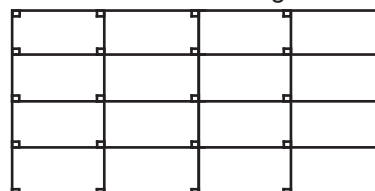

16' x 32'

Accessories



Castor

Castor Adapter

Part Number	Description	Weight
0026-835	5" Castor	4.8
0026-952	8" Castor	9
0105-01-106	Castor adapter (necessary for castor use)	2
0105-30-0038	AS2100 to ST8100 compatibility adapter bracket	16
0105-05T-24	Chair rail 24" long	3
0105-05T-48	Chair rail 48" long	6
0105-01-107	Riser Adapter	2

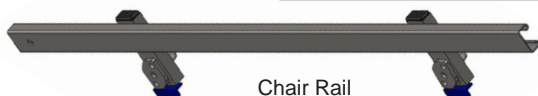

Chair Rail



Riser Adapter

Horizontal Quick-Brace System

Horizontal bracing comes in 4' or 8' sections. Guide posts allow for quick and easy insertion into the legs. A wing nut tightens a clamp on the brace to secure it to the leg. Traditional cross bracing will also work with the AS 2100.



Part Number	Description	Weight
0105-06-101	Horizontal quick brace 4' starter	9
0105-06-102	Horizontal quick brace 4' continuous	10
0105-06-103	Horizontal quick brace 8' starter	15
0105-06-104	Horizontal quick brace 8' continuous	16

*Additional bracing available - contact factory



4' Horizontal Quick Brace Brace

AS 2100 Legs / Foot Pads

Fixed Leg With Adjustable Foot Pad

Fixed legs require no hardware, reducing components and setup time. Rubber base pads allow for use on sensitive surfaces and provide precise height adjustment up to 1 1/2" inches.



Fixed Leg W/Foot Fixed Leg Extension for additional adjustment

Part Number	Description	Weight
0105-0299-005	1 3/4" x 5" Leg for 8" high stage	3
0105-0299-009	1 3/4" x 9" Leg for 12" high stage	3
0105-0299-015	1 3/4" x 15" Leg for 18" high stage	4
0105-0299-021	1 3/4" x 21" Leg for 24" high stage	6
0105-0299-027	1 3/4" x 27" Leg for 30" high stage	6
0105-0298-12	Fixed leg extension 12"	2.25
0105-0298-18	Fixed Leg extension 18"	3
0105-0298-24	Fixed Leg extension 24"	4

*Additional lengths available - contact factory

Adjustable Leg Sets and Base Pads

Telescopic legs allow for height adjustment but require the included snap pins.



Adjustable Leg Set

Part Number	Description	Weight
0105-40-1218	12" - 18" Set (10" sleeve, 10" leg)	5
0105-40-1828	18" - 28" Set (16" sleeve, 16" leg)	8
0105-40-2844	28" - 44" Set (24" sleeve, 24" leg)	11
0068-292-50	2 3/8" Snap pins (box of 50)	6
0030-135	Adjustable Base pad with 1" collar	1
0030-086	Adjustable Base pad without collar	1

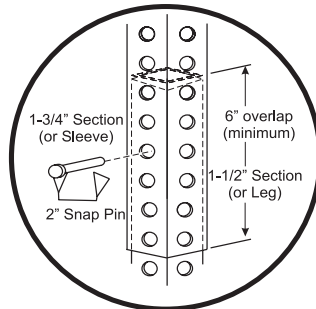

Base Pad



Base Pad W/ Collar

Individual Legs



Part Number	Description	Weight
0065-0299-009	1 3/4" x 9" Leg	2
0065-0299-015	1 3/4" x 15" Leg	3
0065-0299-021	1 3/4" x 21" Leg	4
0065-0299-027	1 3/4" x 27" Leg	5
0065-0299-033	1 3/4" x 33" Leg	6
0065-0298-13	1 1/2" x 13" Leg	2
0065-0298-021	1 1/2" x 21" Leg	3
0065-0298-029	1 1/2" x 29" Leg	4
Leg Stock		
0065-0299-144	1 3/4" x 12' Long stock	25
0065-0298-144	1 1/2" x 12' Long stock	21

Additional leg heights available.

(System scaffold available for heights above five feet.)

AS2100 Guard Rail / Truss Understructure

Guard Rail

Guard panels have been designed for quick assembly to increase productivity during installation and disassembly. Unique clamps snap into the side channel of the decks and release by depressing a plunger.

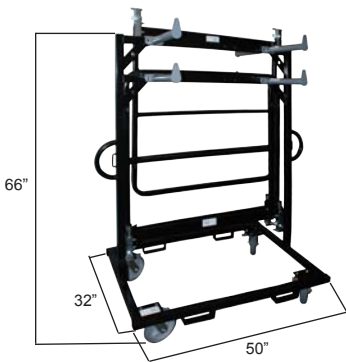

Guard Rail Cart holds up to 16 guardrails.

Part Number	Description	Weight
0105-05-101	4' x 42" H Vertical rails guard rail panel	32
0105-05-102	4' x 42" H Horizontal rail guard rail panel	20
0105-05-107	2' x 42" H Vertical rails guard rail panel	30
0105-05-108	2' x 42" H Horizontal rail guard rail panel	25
Storage Cart		
0105-35-32	Guard rail cart	105

- Easily installed by one person
- Snaps into place
- No loose parts
- Quick-release latches for removal

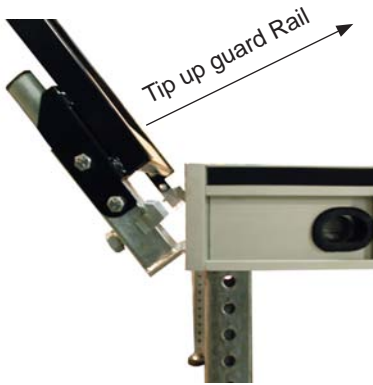

4' Horizontal Guard Panel



4' Vertical Guard Panel

Truss Understructure

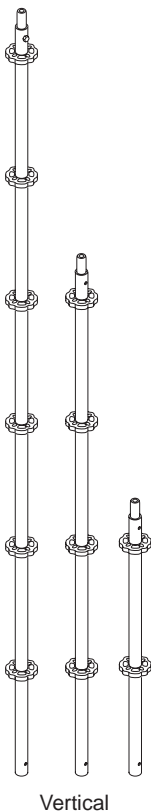

Part Number	Description	Weight
0256-19-110	1.0M Vertical post	7.5
0256-19-115	1.5M Vertical post	15
0256-19-120	2.0M Vertical post	23
0256-02-2024	2ft Horizontal	7
0256-02-2048	4ft Horizontal	11
0256-02-2096	8ft Horizontal	19
0105-256-2024	2ft Truss	10
0105-256-2048	4ft Truss	26
0105-256-2096	8ft Truss	50
0256-11-309610	Vertical diagonal 8FT X 1.0M	18
0256-11-309620	Vertical diagonal 8FT X 2.0M	22
0256-11-304810	Vertical diagonal 4FT X 1.0M	12
0256-11-304820	Vertical diagonal 4FT X 2.0M	18
0032-609	Levelling jack	8
0256-01-100	Starter collar	5

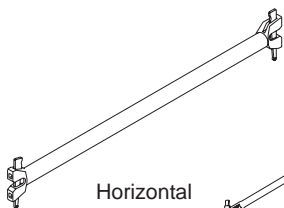

Horizontal Brace

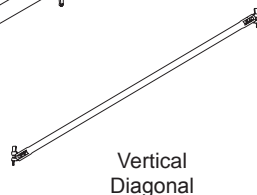

Vertical Diagonal



Starter Collar

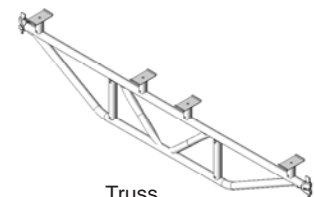

Truss

Presenting Multi-Stage[®]

ST8100 STEEL STAGING - FEATURES AND BENEFITS

Designed to provide a stage unit that is extremely versatile and easy to assemble. Attractive yet rugged enough for various types of community and social activities, events and tent flooring.

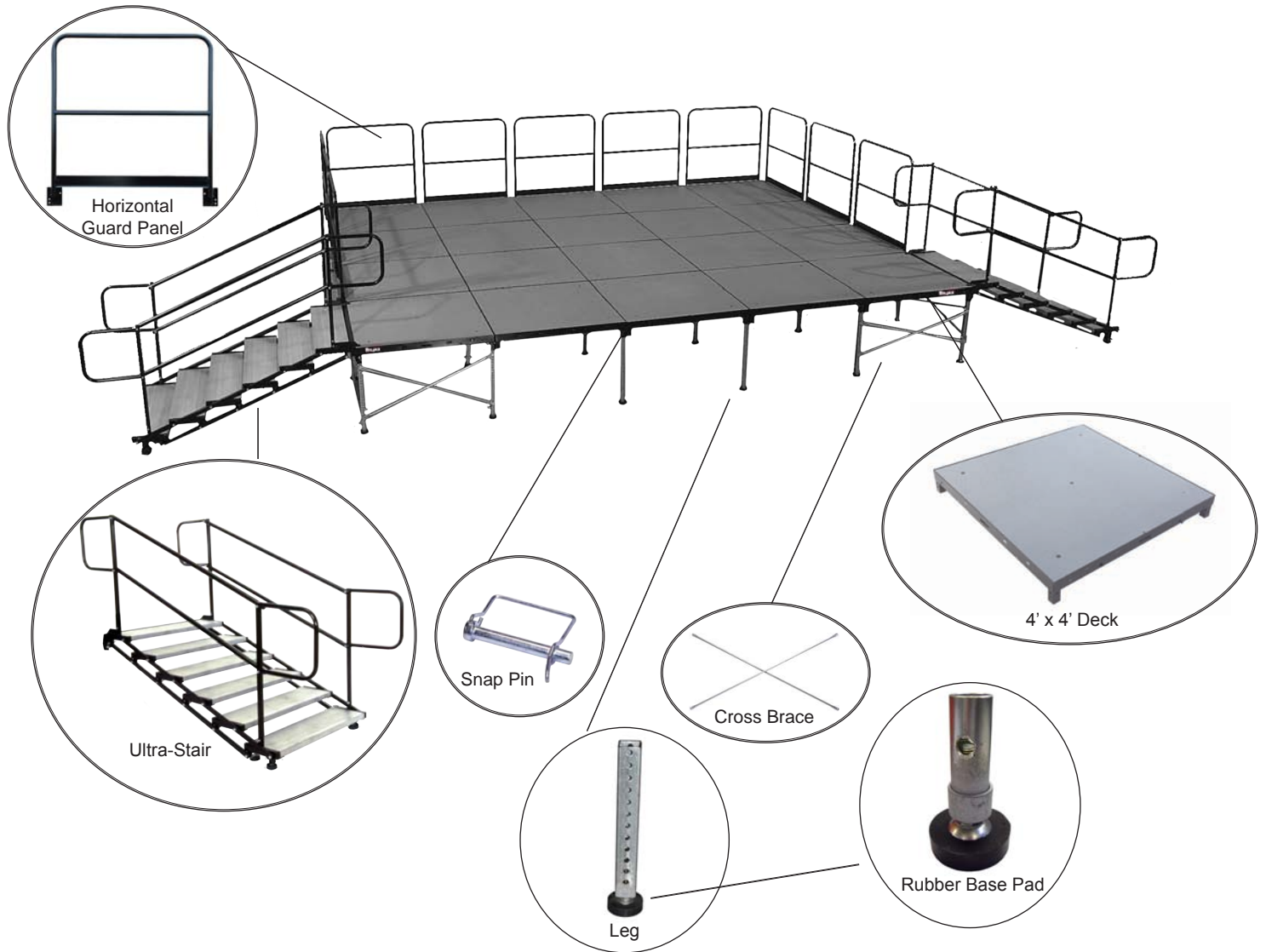

Tent Floor Application



Image Courtesy of PFA Productions

Pool Cover Application

Transparent Decking not available for order.

ST8100 Decking / Storage Cart

Deck Sections

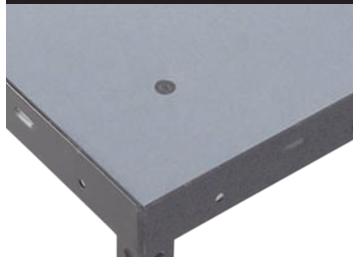

Stained Plywood

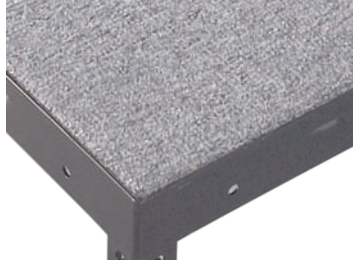

Carpeted Plywood

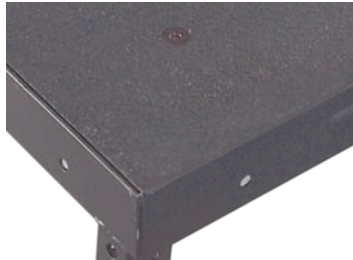

Black Poly Ripple

Part Number	Description	Weight
4' x 4' Steel Frame Deck Sections		
0106-039-6	Deck with 3/4" Gray Stained Plywood	80
0106-052-3	Deck with 5/8" Gray Carpeted Plywood	78
0106-039-7	Deck with 3/4" Black Poly Ripple Plywood	83
2' x 4' Steel Frame Deck Sections		
0106-028-6	Deck with 3/4" Gray Stained Plywood	46
0106-053-3	Deck with 5/8" Gray Carpeted Plywood	48
4' x 4' 45° Corner Steel Frame Deck Sections		
0106-029-6	Deck with 3/4" Gray Stained Plywood	51
0106-054-3	Deck with 5/8" Gray Carpeted Plywood	53
Round Deck Sections		
0106-346-6-1	Left Extension, Gray Stained Plywood Top	26
0106-346-6-2	Right Extension, Gray Stained Plywood Top	26
0106-382-6	19-7/8" x 4' Intermediate, Gray Stained Plywood Top	49
0106-385-6	4' x 4' Round, Gray Stained Plywood Top	80
Additional Deck Sections		
0106-070-6	1' x 4' Deck with 3/4" Gray Stained Plywood	42
0106-231-6	2' x 2' Deck with 3/4" Gray Stained Plywood	24
0106-076-6	2' x 6' Deck with 3/4" Gray Stained Plywood	70
0106-122-6	3' x 4' Deck with 3/4" Gray Stained Plywood	65
Replacement Deck Tops		
0191-0138	4' x 4' 3/4" Gray Stained Plywood	30
0106-057-3	4' x 4' 5/8" Gray Carpeted Plywood	34
0106-12-7	4' x 4' 3/4" Black Poly Ripple Plywood	38



45° Deck

2' x 4' Deck

Possible Configuration:

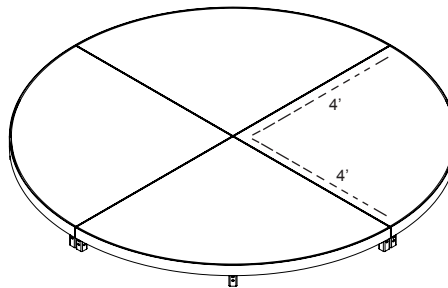

4 - 4' x 4' Round Decks

Storage Carts

Store your decks conveniently and efficiently on Multi-Stage Storage Carts. Solid steel frame construction provides an easy way to transport your decks to and from set up sites.



Part Number	Description	Weight
0106-068	Horizontal Storage Cart, 60"L x 42" W x 38" H	187
0106-390	Vertical Storage Cart, 40.5"L x 35" W x 53" H	138

Vertical Storage Cart -
40.5" L x 35" W x 53" H
Fits through a 36" wide doorway
Stores up to 10 stage decks upright



Horizontal Storage Cart -
60" L x 42" W x 38" H
Stores up to 14 stage decks in a nested configuration

ST8100 Legs / Sleeves / Base Pads / Accessories

Galvanized Legs / Sleeves / Base Pads

Galvanized steel square tubed 1-1/2" legs are perforated for 1" adjustment and are available in standard lengths of 12", 24", 30", 36" and 48". Legs lengths can also be custom cut to fit specific requirements. A rubber base pad provides a solid, non-marring leg base.

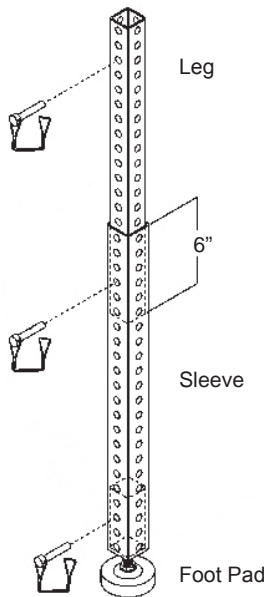

Part Number	Description	Weight
0065-0298-012	1-1/2" Galvanized Leg x 12" Long	2
0065-0298-024	1-1/2" Galvanized Leg x 24" Long	4
0065-0298-030	1-1/2" Galvanized Leg x 30" Long	4
0065-0298-036	1-1/2" Galvanized Leg x 36" Long	5
0065-0298-048	1-1/2" Galvanized Leg x 48" Long	7
0065-0298-144	1-1/2" Galvanized Leg Stock x 12' Long	21

Sleeves

0065-0299-024	1-3/4" Galvanized Sleeve x 24" Long	4
0065-0299-030	1-3/4" Galvanized Sleeve x 30" Long	5
0065-0299-036	1-3/4" Galvanized Sleeve x 36" Long	6
0065-0299-048	1-3/4" Galvanized Sleeve x 48" Long	7
0065-0299-144	1-3/4" Galvanized Leg Stock x 12' Long	25
0030-086	Adjustable rubber base pad	1
0030-135	Adjustable rubber base pad with 1" collar	1



Adjustable Base pad

Adjustable Base pad with collar

For adjustable height applications, adding the 1-3/4" galvanized steel telescopic sleeve allows you the flexibility of attaining:

- Multiple stage heights
- Consistent stage heights on uneven surfaces
- Matching heights of existing platforms
- Creating chair risers

Combining the telescopic legs with the adjustable rubber base pad allows you to obtain any stage height from 6" to 6' within a fraction of an inch*.

* Specific heights limited to length of leg materials used.

Accessories



T-Handle



Part Number	Description	Weight
0068-292-50	2-3/8" Snap Pin (Box of 50)	6.3/ box
0068-102-50	4-1/2" Snap Pin (Box of 50)	12.5/ box
0082-0555	T-Handle, 5/16" Wrench	1
	T-Handle Extension	1
0106-172	F-Clip with Velcro Skirt Attachment (bag of 50)	1

Riser Additions

0106-094	Riser Socket with Hex Nut	2
0106-096	Chair Rail Clamp	2

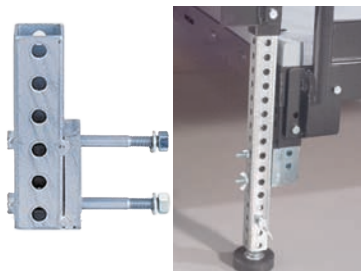

Riser Socket

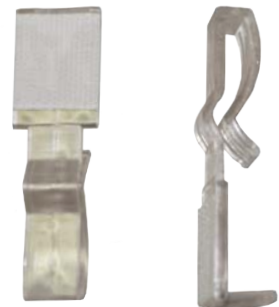

F-Clip Skirt Attachment

ST8100 Guard Rail / Bracing

Guard Railing



4' Horizontal Guard Rail



4' Vertical Guard Rail

Part Number	Description	Weight
0106-214-2	Guard Rail Panel, Horizontal, 2'W x 42"H	18
0106-214-4	Guard Rail Panel, Horizontal, 4'W x 42"H	24
0106-223-2	Guard Rail Panel, Vertical, 2'W x 42"H	22
0106-223-4	Guard Rail Panel, Vertical, 4'W x 42"H	32

BilJax recommends the use of guard railing with the Multi-Stage system.

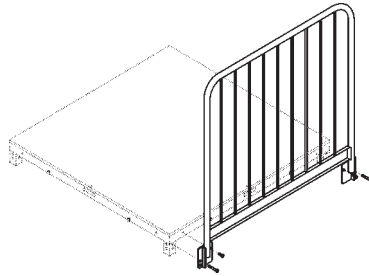

Bracing

Horizontal Braces:

- Easily adapt to low stage heights
- Faster set up

Part Number	Description	Weight
0010-21	Galvanized cross brace	8
0106-06-101	Horizontal 4' starter	8
0105-06-102	Horizontal 4' continuous brace	10
0105-06-110	4' Quick brace starter	10
1005-06-111	4' Quick brace continuous	11

Other braces available. Please contact factory



4' Horizontal Brace

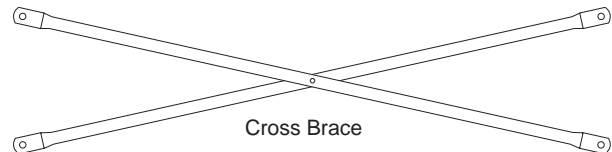

Cross Brace



4' Quick Brace

Build-Up Frames

Part Number	Description	Weight
0106-084	4' High Starter Build-Up Frame	32
0106-083	4' High Continuing Build-Up Frame	33

Combine 4' high build up frames with standard 1-1/2" legs to reach stage heights of 8'. Two frames can be stacked to achieve higher applications. Coupling inserts (1-1/2") are attached to buildup frames for quick, secure stacking. Using these frames is like having two legs in one with built-in bracing, thus eliminating pieces and set up time.

These frames are ideal for large scale tiered seating.

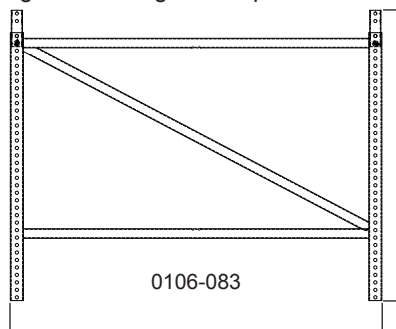

0106-083

48"

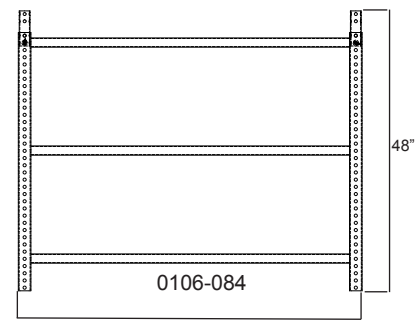

0106-084

48"

Stair Units Compatible with both AS2100 and ST8100

Adjustable Stair Units

The Ultra-Stair decreases set up time and labor. Multiple options are available for platform heights from 12" to 70". The units, with detachable handrails, fold flat for storage and ease of shipment. Stairs can be attached to any section of the AS 2100 or ST8100 decks, regardless of size and dimension. They can also be attached to 45° decks to create a unique setup. The Ultra-Stairs attach to the AS 2100 series with an easy to install adaptor bracket.



Four Step Ultra-Stair

Part Number	Description	Weight
0105-0016	Ultra-Stair Adaptor Bracket and ST8100 to AS2100 Staging adaptor bracket	25
0106-420	Stabilizer Foot	4
AS2100 Ultra-Stair		
0105-450-3	AS2100 Ultra-Stair 3 step unit - 12" to 21"	135
0105-450-4	AS2100 Ultra-Stair 4 step unit - 16" to 28"	174
0105-450-6	AS2100 Ultra-Stair 6 step unit - 24" to 42"	238
0105-450-8	AS2100 Ultra-Stair 8 step unit - 32" -56"	258
0105-260	AS2100 Ultra-Stair 10 step unit - 40" to 70"	372
ST8100 Ultra-Stair		
0106-450-3	ST8100 Ultra-Stair 3 step unit - 12" to 21"	135
0106-450-4	ST8100 Ultra-Stair 4 step unit - 16" to 28"	174
0106-450-6	ST8100 Ultra-Stair 6 step unit - 24" to 42"	238
0106-450-8	ST8100 Ultra-Stair 8 step unit - 32" -56"	258
0106-260	ST8100 Ultra-Stair 10 step unit - 40" to 70"	372



Ultra-Stair Adaptor Bracket
ST8100 to AS2100 Staging Adaptor Bracket

Quick Step Units

The 2 step and 3 step fixed stair units are both quick and easy to use and come with non-marring rubber footpads.

Part Number	Description	Weight
0105-37-12	Quick-Stair 12" high 2 step unit	77
0105-37-18	Quick-Stair 18" high 3 step unit	103



Quick-Stair 2 step unit



Quick-Stair 3 step unit

Staging Ramps Compatible with AS2100 and ST8100

EX:	Part Number	Description	Quantity Needed 12" high stage	Quantity Needed 24" high stage	Weight (each)
	RAMP COMPONENTS KIT NUMBER		0105-47-12H	0105-47-24H	
1	0105-45-0001	Ramp end	1	1	68
2	C105-20-7	4' x 8' Black Poly AS2100 Deck	1	2	132
	C105-22-7	4' x 4' Black Poly AS2100 Deck	0	1	72
3	0105-45-0008	Ramp guard panel end	2	2	22
4	0105-05-102 (101)	Horizontal guard rail panel (or vertical)	4	10	20 (34)
5	0105-45-0005	Ramp base plate	2	2	3
6	0105-45-0003	Ramp leg adapter	2	2	1.5
7	0105-0299-005	5" fixed leg	2	2	2.5
	0105-0299-013	13" fixed leg	0	2	
	0105-0299-018	18" fixed leg	0	2	5
8	0105-45-0016	Ramp filler plate	1	1	8.8
	ADDITIONAL PARTS NECESSARY FOR ADA COMPLIANCE				
	ADA COMPONENTS KIT NUMBER		0105-48-12	0105-48-24	
9	0105-45-0011	End hand rail	2	2	4.6
10	0105-45-0010	4' Hand rails	4	10	5.2
11	0105-45-0015	Top hand rail kit	1	1	25
12	0105-45-0014	Filler guard rails	2	2	14

*For different stage heights, please contact factory for necessary configurations

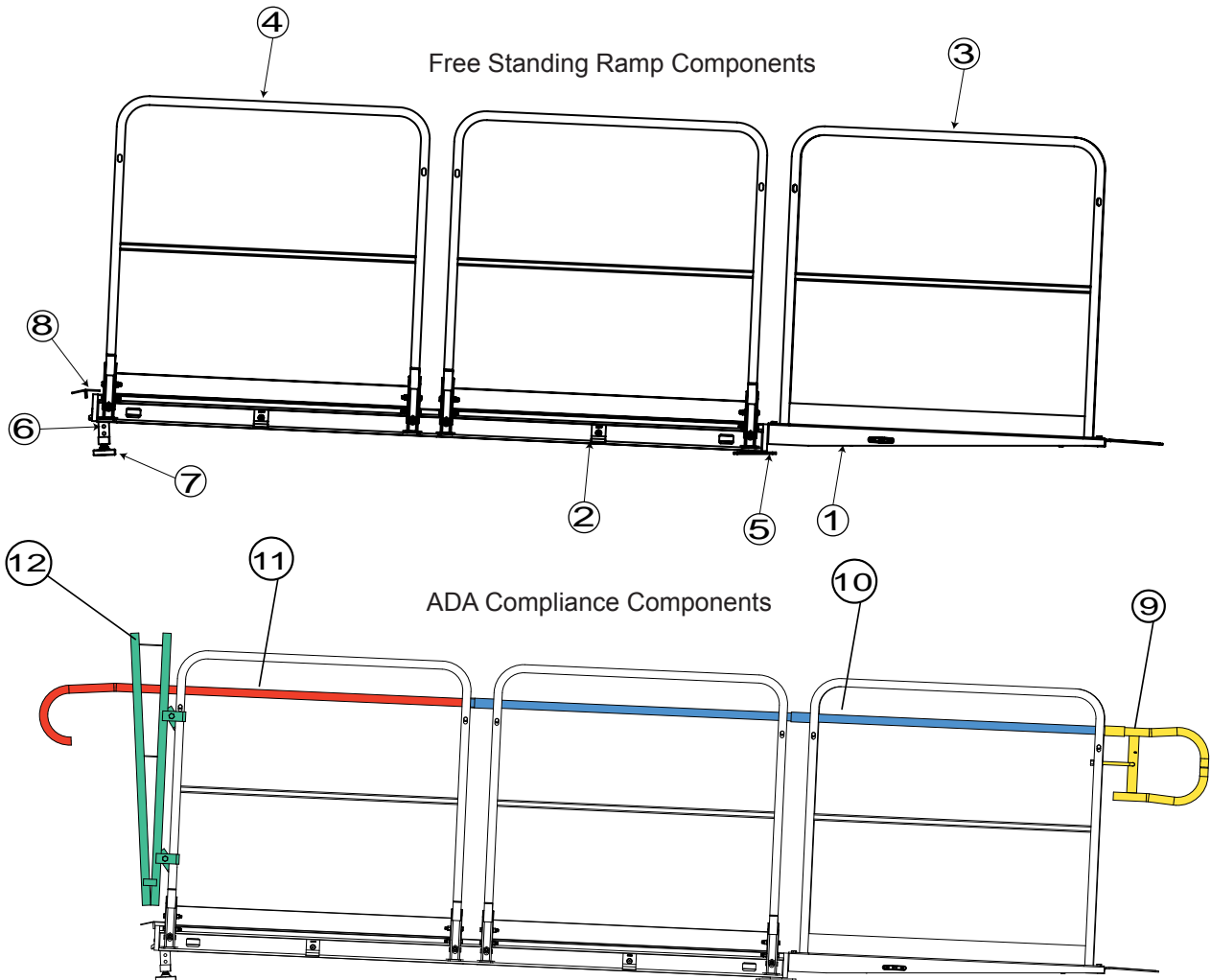



308 Tip-up Bleacher with bench Seats



5 Row with Guard Rail



4 Row Tip and Roll



308 Elevated Grandstand



308 Elevated



308 Non-elevated

Event Seating

Presenting Seating

308 Tip-Up Bleachers

Generally the two systems of a bleacher setup are Elevated and the other Non-Elevated. The Elevated bleacher features a front walkway that can be 2ft or 3ft or 4 ft elevated from the ground. The front walkway frames are 6ft long and must use this frame to make the walkway in front of the bleacher.

The minimum number of rows with the 308 Tip-Up seat is 5 rows.

When another frame is added, the number of rows will be increased by 2 rows. This row increment system is applicable for elevated and non-elevated bleachers.

For Example: The minimum number of rows is 5, then 7, then 9

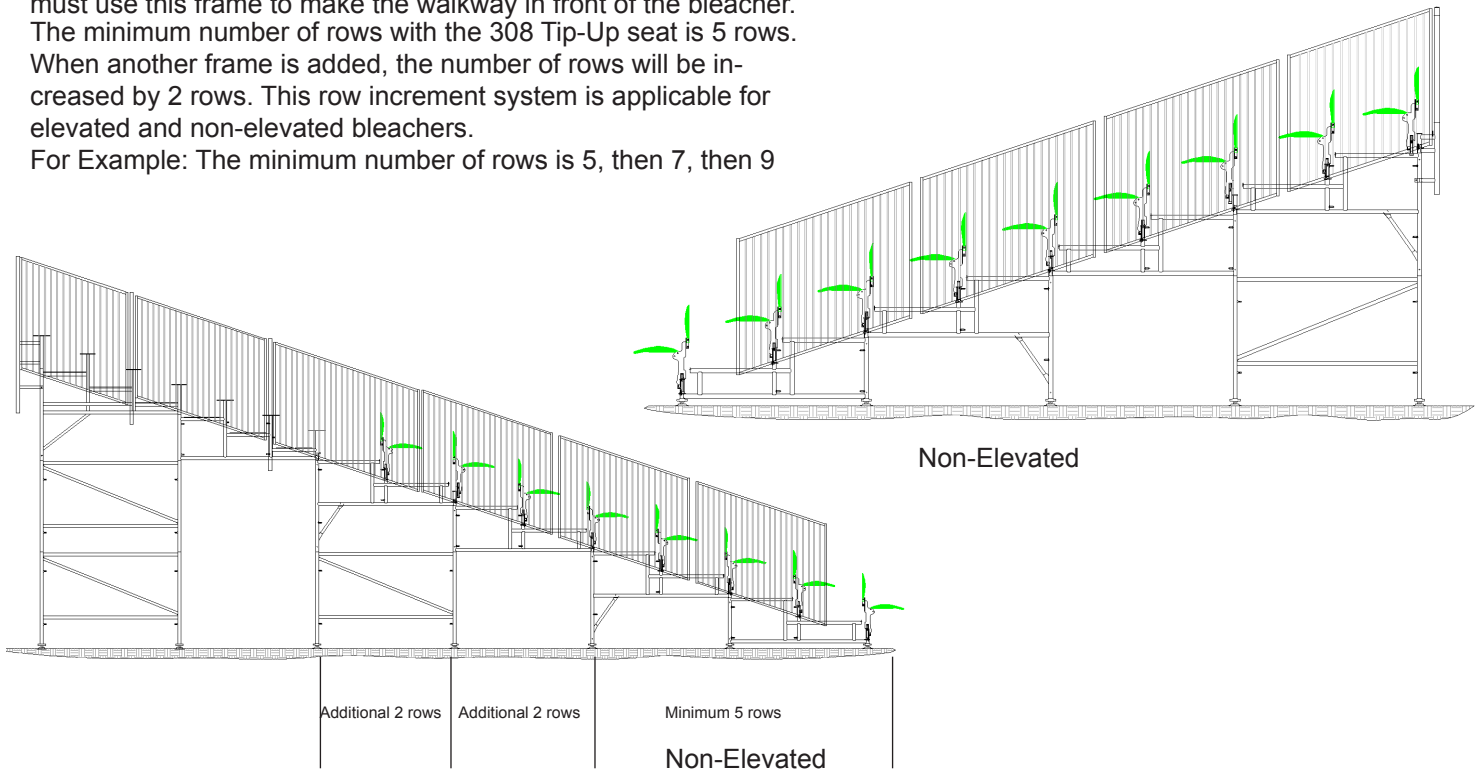

308 Tip-Up Bleachers - FEATURES AND BENEFITS

Unique in the market place with Tip-up seat, flooring, guard rail system, and a frame and brace understructure.

Includes a two seat option of using Tip-Up plastic seats or bench type aluminum extruded seats. Compatible with the 308 Bleacher System.

Endless set up possibilities

- Painted or galvanized frames
- New 308 Tip-Up seat is 20" wide
- Any number of seats can be in a row with no need to be a multiple of 3 or 2
- One set up can provide Tip-up seats as well as bench seats
- New floor boards reduce setup time as well as ease transportation
- More leg room for comfort. The tip-up seats will provide 12" more leg space for people to pass in front
- 12" Rise and 36" depth for seating with the tip-up seats

308 Bench Seat Bleachers - FEATURES AND BENEFITS

Benches, flooring, guard rail system, and a frame and brace understructure. Available in depths from 7 to 21 rows, the system can accommodate all events with seating requirements from 70 seats to 60,000 seats or more. For more than 21 rows, contact the factory.

Expansive uses

- Constructed from tubular steel frames and braces, the 308 Series Bleacher is easy to erect, yet strong and secure
- Guard railing, front walkways and stairs are standard, allowing secure access and exit the seating system
- Our application engineer can design a seating system for any entertainment or sporting venue
- A stadium planner is available to assist in determining specific requirements for any larger seating application
- 8" Rise and 12" depth for bench seating

Tip Up Seating

This tip-up seating provides you with flexibility in terms of number of seats for each set-up. The seats are 20" wide plastic seats that tip-up with gravity. The seat frames are painted black (powder coated).

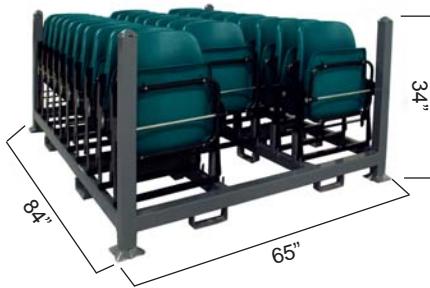

Part Number	Description	Weight
0212-0001	3-Seat Frame	40
0212-0002	2-Seat Frame	28
0212-0003	1-Seat Frame	16

*Minimum Order quantities

Rack

0212-100-001	Seat Rack (10 SEAT FRAME)
--------------	---------------------------

*Different seating colors available if meets minimum quantity requirement

Stacking racks available for all seat frames. Various seat frame sizes will fit on the same rack. The rack accommodates up to 30 seats and are stackable.



One Seat



Two Seat



Three Seat

Bench Seating

Part Number	Description	Weight
0075-117A-90	7.5 ft/ 90 in Minimum Order length	
0075-117A-288	24 ft/ 288 in Maximum Order length	

*Double for walkway use

* Contact Factory for available lengths between Min/Max

Walkway

The walkway floor boards are aluminum framed planks and are 22" wide for bench seats and 32" wide for tip-up seats. The plywood top of the floor board is overlaid with Phenolic film and the bottom side of the plywood is protected against weather. One side of the walkboard hooks are locking which secure the plank to the frame.



Part Number	Description	Weight
0054-308-2272-1BK	Walkboard 22" W x 6' L	28
0054-308-2272-2BK	Walkboard 22" W x 6' L Both Ends	30
0054-212-3272-1BK	Walkboard 32" W x 6' L	38
0054-212-3272-2BK	Walkboard 32" W x 6' L both ends	40

For aluminum walkways, contact factory



Aluminum Walkway

Stairs



Part Number	Description	Weight
0102-0209	Stair Stringer Hanging Frame 4ft	26
0102-4027	Guard Rail Stair w/ Hand Rail Panel (L&R) 4ft	213
0102-4028	Kit 7 Steps 48" w/ Clips for 4ft Stair	63
0102-4063	Guard Rail Stair w/ Hand Rail Panel (L&R) 2ft	200
0102-1315	Stair Stringer Hanging Frame 2ft	23
0102-4064	Kit 4 Steps 48" w/ Clips for 2ft Stair	36
0102-0418	Kit 308 BI Alum Hold Down Clamp	.25
0102-0467	Seat Board Clip	4

Elite Seat / Crowd Control Barrier

ELITE SEAT 4 4-Row Steel Understructure W/ Aluminum Seats and Footboards

The Elite Seat 4 and 5 row portable bleacher systems are comprised of mill finish aluminum seat boards and extruded aluminum footboards. With only a 6" rise, these portable bleachers meet IBC and UBC Codes* while remaining flexible in use.

TIP & ROLL

Part Number	Description	Weight
0102-3108	9' Length, Seating Capacity 24	210
0102-3180	15' Length, Seating Capacity 40	345
0102-3252	21' Length, Seating Capacity 55	477



Ideal for rental, these units feature quick setup and easy storage. Four casters located on the back of the Elite Seat 4 allow for tip-up transportation, even through 36" doorways. They are also available in an "understructure only" version for those customers who have their own wood seat and foot boards.

ELITE SEAT 4 4-Row Steel Understructure Only

Part Number	Description	Weight
0102-3096	6' Length, Seating Capacity 20	85
0102-3168	12' Length, Seating Capacity 36	140
0102-3240	18' Length, Seating Capacity 50	190

ELITE SEAT 5 5-Row Steel Understructure W/ Aluminum Seats & Footboards and Guard Railing



Part Number	Description	Weight
0102-2108	9' Length, Seating Capacity 30	610
0102-2180	15' Length, Seating Capacity 50	890
0102-2252	21' Length, Seating Capacity 70	1170

Meets all IBC and UBC Codes*

ELITE SEAT 5 5-Row Steel Understructure Only W/ Guard Railing

Part Number	Description	Weight
0102-2096	6' Length, Seating Capacity 25	425
0102-2168	12' Length, Seating Capacity 45	575
0102-2240	18' Length, Seating Capacity 65	730

* 2" x 10" footboards and 2" x 12" seat boards of bleacher grade or equivalent wood are required to meet IBC and UBC codes. These codes require that any bleacher with a seat height greater than 30" from the ground must have guardrail.

AB Elite Grandstand Seating / Crowd Control Barrier

AB Elite Grandstands

Portable seating system for 36 - 20,000+ seats
Supported using BilJax System Scaffold



Tip Up Plastic Seats for Maximum Comfort and Durability - Easy and Fast to Setup

Portable system provides the comfort of permanent seats with full backrests.

- 9 basic components can be combined to create full row seating with side aisles, center aisle seating, seating with entertainment skyboxes, or floor seating. This is a very flexible design.
- The seating structure is constructed from the highest quality materials; and then hot dipped galvanized to provide superior corrosion resistance.
- Corner components, all styles of access, even palletized storage systems are available to reduce storage and transportation costs.
- Flooring and aisle materials are designed to last a minimum of 10 years under normal use.

Ideal Applications include but are not limited to...

Tennis and Golf Tournaments, Auto and Power Boat Racing, Swim Meets, Gymnastics, Boxing Matches, Basketball, Soccer, Baseball and Other Sporting Events, Casino Events, Amusement and Entertainment Venues

Contact the factory today for your custom set-up

Crowd Control Barrier



8' Long x 44" High

Part Number	Description	Weight
C107-119HD	8' Crowd Control Barrier Section w/ feet	52

- Self supporting fence sections with removable feet
- 8' long x 44" high sections constructed of high strength steel
- Hot dipped galvanize finish for extreme durability



Other Offerings from Haulotte Group



0205-1003 Haulotte Group | Bil-Jax 2014 - Printed in the USA